

Specification

DRAFT

LEVEL 3 CAMBRIDGE ADVANCED NATIONAL (AAQ) IN

# ENGINEERING

**Certificate H027**

**Extended Certificate H127**

For first teaching in 2025

## Tell us what you think

Your feedback plays an important role in how we develop, market, support and resource qualifications now and into the future. Here at OCR, we want teachers and students to enjoy and get the best out of our qualifications and resources, but to do that we need honest opinions to tell us whether we're on the right track or not. That's where you come in.

You can email your thoughts to [ProductDevelopment@OCR.org.uk](mailto:ProductDevelopment@OCR.org.uk) or visit the [OCR feedback page](#) to learn more about how you can help us improve our qualifications.



Designed and tested with teachers and students



Helping young people develop an ethical view of the world



Equality, diversity, inclusion and belonging (EDIB) are part of everything we do

## Are you using the latest version of this specification?

The latest version of our specifications will always be on [our website](#) and may differ from printed versions. We will inform centres about changes to specifications.

### Disclaimer

Specifications are updated over time. Whilst every effort is made to check all documents, there may be contradictions between published resources and the specification, therefore, please use the information on the latest specification at all times. Where changes are made to specifications these will be indicated within the document, there will be a new version number indicated, and a summary of the changes. If you do notice a discrepancy between the specification and a resource please contact us at: [resources.feedback@ocr.org.uk](mailto:resources.feedback@ocr.org.uk)

### Copyright

© 2023 OCR. All rights reserved.

OCR retains the copyright on all its publications, including the specifications. However, registered centres for OCR are permitted to copy material from this specification booklet for their own internal use.

# OCR Level 3 Cambridge Advanced Nationals (AAQs) in Engineering

OCR Level 3 Cambridge Advanced National (AAQ) in Engineering (Certificate)  
(180 GLH)

Code H027

OCR Level 3 Cambridge Advanced National (AAQ) in Engineering (Extended  
Certificate) (360 GLH)

Code H127

© OCR 2023

This document can be reproduced for teaching purposes.

Centres cannot reproduce OCR materials if the purpose is to sell the materials (to students or others).  
Permission to make this document available on an internet site must be obtained in writing from OCR's  
copyright Team at OCR, The Triangle Building, Shaftesbury Road, Cambridge, CB2 8EA. Email:  
[ocr.copyright@ocr.org.uk](mailto:ocr.copyright@ocr.org.uk). For full details of OCR's copyright policy please see our website.

# 1 Contents

1	Why choose OCR?	5
1.1	Our specifications	5
1.2	Our support	5
1.2.1	More help and support	6
1.3	Aims and learning outcomes	6
1.4	What are the key features of this specification?	6
2	Qualification overview	7
2.1	OCR Level 3 Cambridge Advanced National (AAQ) in Engineering (Certificate) at a glance	7
2.2	OCR Level 3 Cambridge Advanced National (AAQ) in Engineering (Extended Certificate) at a glance	9
2.3	Qualification structure	10
2.4	Purpose statement – Certificate	12
2.5	Purpose statement – Extended Certificate	15
3	About these qualifications	20
3.1	Qualification size	20
3.2	Availability and language	20
3.3	Prior knowledge and experience	20
4	Units	21
4.1	Guidance on unit content	21
4.1.1	Externally assessed units (F130, F131 and F138)	21
4.1.2	NEA units (F132 – F137)	22
4.1.3	Command words	22
4.1.4	Performance objectives (POs):	22
4.2	Externally assessed units	23
4.2.1	Unit F130: Principles of engineering	23
4.2.2	Unit F131: Materials science and technology	37
4.2.3	Unit F138: Mathematics for engineering	44
4.3	NEA Units	53
4.3.1	Unit F132: Engineering in practice	53
4.3.2	Unit F133: Computer Aided Design (CAD)	63
4.3.3	Unit F134: Programmable electronics	73
4.3.4	Unit F135: Mechanical product design	81
4.3.5	Unit F136: Computer Aided Manufacture (CAM)	89
4.3.6	Unit F137: Electrical devices and circuits	100
5	Assessment and grading	112
5.1	Overview of the assessment	112
5.2	Synoptic assessment	115

5.3	Transferable skills.....	115
5.4	Grading and awarding grades .....	116
5.5	Performance descriptors .....	118
6	Non examined assessment (NEA) units .....	120
6.1	Preparing for NEA unit delivery and assessment .....	120
6.1.1	Centre and teacher/assessor responsibilities.....	120
6.2	Requirements and guidance for delivering and marking the OCR-set assignments .....	121
6.2.1	Scope of assessment modification .....	124
6.2.2	Ways to authenticate work .....	124
6.2.3	Group work.....	124
6.2.4	Plagiarism.....	124
6.3	Feedback.....	126
6.3.1	Reporting suspected malpractice .....	128
6.3.2	Student and centre declarations.....	128
6.3.3	Generating evidence .....	128
6.3.4	Teacher Observation Records .....	129
6.3.5	Presentation of the final piece of work .....	130
6.4	Assessing NEA units .....	130
6.4.1	Applying the assessment criteria.....	131
6.4.2	Annotating students' work .....	131
6.4.3	Internal standardisation .....	132
6.4.4	Resubmitting work to OCR to improve the grade.....	132
6.4.5	Submitting outcomes.....	132
6.5	Moderating NEA units.....	132
6.5.1	Sample requests .....	133
7	Administration .....	134
7.1	Assessment availability .....	134
7.2	Equality Act information relating to Cambridge Advanced Nationals (AAQs).....	134
7.3	Accessibility .....	134
7.4	Requirements for making an entry .....	135
7.4.1	Making estimated unit entries.....	135
7.4.2	Making final unit entries.....	135
7.5	Certification rules.....	136
7.6	Unit and qualification resits.....	136
7.7	Post-results services .....	136
Appendix A: Guidance for the production of electronic evidence .....		137
Structure for evidence .....		137
Data formats for evidence .....		137
Appendix B: Command Words.....		139

External assessment..... 139  
Non examined assessment (NEA)..... 141

DRAFT

# 1 Why choose OCR?

Choose OCR and you've got the reassurance that you're working with one of the UK's leading exam boards. We've developed our specifications in consultation with teachers, employers, subject experts and higher education institutions (HEIs) to give students a qualification that's relevant to them and meets their needs.

We're part of Cambridge University Press & Assessment. We help millions of people worldwide unlock their potential. Our qualifications, assessments, academic publications and original research spread knowledge, spark curiosity and aid understanding around the world.

We work with a range of education providers in both the public and private sectors. These include schools, colleges, HEIs and other workplaces. Over 13,000 centres choose our A Levels, GCSEs and vocational qualifications including Cambridge Nationals and legacy Cambridge Technicals.

## 1.1 Our specifications

We provide specifications that help you bring the subject to life and inspire your students to achieve more.

We've created teacher-friendly specifications based on extensive research and engagement with the teaching community. Our specifications are designed to be straightforward to deliver and accessible for students. The design allows you to tailor the delivery of the course to suit your needs.

## 1.2 Our support

We provide a range of support services to help you at every stage, from preparation to delivery:

- A wide range of high-quality creative resources including resources created by leading organisations in the industry.
- Textbooks and teaching and learning resources from leading publishers. The Cambridge Advanced Nationals (AAQs) page on our website has more information about all the published support for the qualifications that we have endorsed.
- Professional development for teachers to meet a range of needs. To join our training (either face-to-face or online) or to search for training materials, go to the **Professional Development page** on our website.
- **Active Results** which is our free results analysis service. It helps you review the performance of individual students or whole groups.
- **ExamBuilder** which is our free question-building platform. It helps you to build your own tests using past OCR exam questions.
- OCR Subject Advisors, who give information and support to centres. They can help with specification and non examined assessment (NEA) advice, updates on resources developments and a range of training opportunities. They use networks to work with subject communities and share ideas and expertise to support teachers.

### 1.2.1 More help and support

Whether you are new to OCR or already teaching with us, you can find useful information, help and support on our **website**. Or get in touch:

[support@ocr.org.uk](mailto:support@ocr.org.uk)

[@ocrexams](#)

01223 553998

## 1.3 Aims and learning outcomes

Our Cambridge Advanced Nationals (AAQs) in Engineering will encourage students to:

- develop key knowledge, understanding and skills, relevant to the subject
- think creatively, innovatively, analytically, logically and critically
- develop valuable communication skills that are important in all aspects of further study and life
- develop transferable learning and skills, such as communication, problem solving, planning, and evaluation skills, that are important for progression to HE and can be applied to real-life contexts and work situations
- develop independence and confidence in applying the knowledge and skills that are vital for progression to HE and relevant to the Engineering sector and more widely.

## 1.4 What are the key features of this specification?

The key features of OCR's Cambridge Advanced Nationals (AAQs) in Engineering for you and your students are:

- a simple and intuitive assessment model, that has:
  - externally assessed units, which focus on subject knowledge and understanding
  - applied and practical non examined assessment units (NEA)
  - optional NEA units to provide flexibility
- a specification developed with teachers specifically for teachers. The specification lays out the subject content, assessment criteria, teacher guidance and delivery requirements clearly
- a flexible support package made based on teachers' needs. The support package will help teachers to easily understand the qualification and how it is assessed
- a team of OCR Subject Advisors who directly support teachers
- a specification designed to:
  - complement A Levels in a Post-16 curriculum
  - develop wider transferable skills, knowledge and understanding desired by HEIs. More detail about the transferable skills these qualifications may develop is in **Section 5.3**.

All Cambridge Advanced Nationals (AAQs) qualifications offered by OCR are regulated by Ofqual, the Regulator for qualifications offered in England.

The qualification numbers for OCR's Cambridge Advanced Nationals (AAQs) in Engineering are:

- Certificate: TBC
- Extended Certificate: TBC



## 2 Qualification overview

### 2.1 OCR Level 3 Cambridge Advanced National (AAQ) in Engineering (Certificate) at a glance

Qualification number	TBC
First entry date	01 September 2025
Guided learning hours (GLH)	180
Total qualification time (TQT)	230
OCR entry code	H027
Approved age range	16-18, 18+, 19+
Offered in	England only
Performance table information	This qualification is designed to meet the Department for Education's requirements for qualifications in the Alternative Academic Qualifications category of the 16-19 performance tables.
Eligibility for funding	This qualification meets funding approval criteria.
UCAS Points	This qualification is recognised in the UCAS tariff tables. You'll find more information on the <b>UCAS website</b> .
This qualification is suitable for students who:	<ul style="list-style-type: none"> <li>• are age 16-19 and on a full-time study programme</li> <li>• want to develop applied knowledge and skills in Engineering</li> <li>• want to progress onto other related study, such as higher education courses in Engineering</li> </ul>
Entry requirements	There is no requirement for students to achieve any specific qualifications before taking this qualification. However, it is assumed that students are familiar with the content of the current GCSE (9–1) Mathematics specification.
Qualification requirements	Students must complete two units: <ul style="list-style-type: none"> <li>• one externally assessed unit</li> <li>• one NEA unit</li> </ul>
Assessment method/model	Unit F130 is assessed by an exam and marked by us. You will assess the NEA unit and we will validate it.  The NEA assignments will be valid for two years. The dates for which they are live will be shown on the front cover. You must make sure you use a live assignment for students' assessments and submit in the period in which assignments are live.
Exam series each year	<ul style="list-style-type: none"> <li>• January</li> <li>• June</li> </ul>

Exam resits	Students can resit the examined unit twice before they complete the qualification.
NEA submission	<p>There are two windows each year to submit NEA outcomes and request a moderation visit by an OCR Assessor.</p> <p>You must make unit entries for students before you can submit outcomes to request a visit.</p> <p>All dates are on our administration pages.</p>
Resubmission of students' NEA work	<p>If students have not performed at their best in the NEA assignments, they can improve their work and submit it to you again for assessment. They must have your agreement and you must be sure it is in the student's best interests.</p> <p>We use the term 'resubmission' when referring to student work that has previously been submitted to OCR for moderation. Following OCR moderation, a student can attempt to improve their work for you to assess and provide the final mark to us. There is one resubmission opportunity per NEA assignment.</p> <p>All work submitted (or resubmitted) must be based on the assignment that is live for assessment.</p> <p>For information about feedback see <b>Section 6</b>. The final piece of work must be completed solely by the student and teachers must not detail specifically what amendments should be made.</p>
Grading	Information about unit and qualification grading is in <b>Section 5</b> .

## 2.2 OCR Level 3 Cambridge Advanced National (AAQ) in Engineering (Extended Certificate) at a glance

Qualification number	TBC
First entry date	01 September 2025
Guided learning hours (GLH)	360
Total qualification time (TQT)	480
OCR entry code	H127
Approved age range	16-18, 18+, 19+
Offered in	England only
Performance table information	This qualification is designed to meet the Department for Education's requirements for qualifications in the Alternative Academic Qualifications category of the 16-19 performance tables.
Eligibility for funding	This qualification meets funding approval criteria.
UCAS Points	This qualification is recognised in the UCAS tariff tables. You'll find more information on the <b>UCAS website</b> .
This qualification is suitable for students who:	<ul style="list-style-type: none"> <li>• are age 16-19 and on a full-time study programme</li> <li>• want to develop applied knowledge and skills in Engineering</li> <li>• want to progress onto other related study, such as higher education courses in Engineering</li> </ul>
Entry requirements	There is no requirement for students to achieve any specific qualifications before taking this qualification. However, it is assumed that students are familiar with the content of the current GCSE (9–1) Mathematics specification.
Qualification requirements	Students must complete five units: <ul style="list-style-type: none"> <li>• two mandatory externally assessed units</li> <li>• one mandatory NEA unit</li> <li>• two optional units</li> </ul>
Assessment method/model	Units F130, F132 and F138 are assessed by an exam and marked by us.  You will assess the NEA units and we will validate them.  The NEA assignments will be valid for two years. The dates for which they are live will be shown on the front cover. You must make sure you use a live assignment for students' assessments and submit in the period in which assignments are live.
Exam series each year	<ul style="list-style-type: none"> <li>• January</li> <li>• June</li> </ul>

Exam resits	Students can resit each examined unit twice before they complete the qualification.
NEA Submission	<p>There are two windows each year to submit NEA outcomes and request a moderation visit by an OCR Assessor.</p> <p>You must make unit entries for students before you can submit outcomes to request a visit.</p> <p>All dates are on our administration pages.</p>
Resubmission of students' NEA work	<p>If students have not performed at their best in the NEA assignments, they can improve their work and submit it to you again for assessment. They must have your agreement and you must be sure it is in the student's best interests.</p> <p>We use the term 'resubmission' when referring to student work that has previously been submitted to OCR for moderation. Following OCR moderation, a student can attempt to improve their work for you to assess and provide the final mark to us. There is one resubmission opportunity per NEA assignment.</p> <p>All work submitted (or resubmitted) must be based on the assignment that is live for assessment.</p> <p>For information about feedback see <b>Section 6</b>. The final piece of work must be completed solely by the student and teachers must not detail specifically what amendments should be made.</p>
Grading	Information about unit and qualification grading is in <b>Section 5</b> .

## 2.3 Qualification structure

Key to units for these qualifications:

- M = Mandatory                      Students must complete these units.
- O = Optional                         Students must complete some of these units.
- E = External assessment          We set and mark the exams.
- N = NEA                                We set the assignment. You assess the assignment and we validate it.

### OCR Level 3 Cambridge Advanced National (AAQ) in Engineering (Certificate)

For this qualification, students must complete two units:

- One mandatory externally assessed unit
- One mandatory NEA unit

Unit no	Unit title	Unit ref no (URN)	Guided learning hours (GLH)	How is it assessed?	Mandatory or optional
F130	Principles of engineering	TBC	90	E	M
F132	Engineering in practice	TBC	90	N	M

### OCR Level 3 Cambridge Advanced National (AAQ) in Engineering (Extended Certificate)

For this qualification, students must complete five units:

- Two mandatory externally assessed units
- One mandatory NEA units
- Two optional units

Unit no	Unit title	Unit ref no (URN)	Guided learning hours (GLH)	How is it assessed?	Mandatory or optional
F130	Principles of engineering	TBC	90	E	M
F131	Materials science and technology	TBC	60	E	M
F132	Engineering in practice	TBC	90	N	M
F133	Computer Aided Design (CAD)	TBC	60	N	O
F134	Programmable electronics	TBC	60	N	O
F135	Mechanical product design	TBC	60	N	O
F136	Computer Aided Manufacture (CAM)	TBC	90	N	O
F137	Electrical devices and circuits	TBC	60	N	O
F138	Mathematics for engineering	TBC	60	E	O

## 2.4 Purpose statement – Certificate



OCR Level 3 Cambridge Advanced National (AAQ) in Engineering (Certificate)

Qualification number: TBC

### Overview

#### Who this qualification is for

The OCR Level 3 Cambridge Advanced National (AAQ) in Engineering (Certificate) is for students aged 16-19 years old. It will develop knowledge, understanding and skills that will help prepare you for progression to undergraduate study and are relevant to the engineering sector.

You might be interested in this qualification if you want to apply what you learn to practical, real-life contexts, such as:

- Carrying out a product analysis by completing a mechanical inspection.
- Producing two-dimensional (2D) Computer Aided Design (CAD) drawings.
- Manufacturing a prototype electronic circuit.

The qualification will also help you develop independence and confidence in using skills that are relevant to the sector and that prepare you for progressing to university courses where independent study skills are needed. You will develop the following transferable skills that can be used in both higher education and other life and work situations:

- Safe working practices. Safety always comes first in engineering. Working safely requires good planning skills and the ability to manage both resources and time effectively.
- Communicating effectively with individuals or groups. Communication is important for engineers to ensure that ideas and solutions can be shared and understood by others.
- Using thinking and problem-solving skills in order to identify solutions and improvements.
- Project-based skills. Engineers often work as part of a wider team to ensure that projects are completed.

This qualification will complement other learning that you're completing at Key Stage 5. If you are a full-time student, it will be part of your studies along with A Levels.

#### What you will study when you take this qualification

Through a combination of theoretical study and hands-on experience, you will develop the necessary knowledge and skills that can support progression to higher education engineering study.

In the examined units, you will study key knowledge and understanding relevant to engineering. In the non examined assessment (NEA) unit, you will demonstrate knowledge and skills you learn by completing a practical assignment. More information about the knowledge and skills you will develop is below.

All units in the qualification are mandatory. You must take **both** of these units:

- **F130: Principles of engineering**

This unit is assessed by an exam.

In this unit you will learn about the mathematical techniques, forces and the electrical/electronic principles widely used in the engineering industry. Topics include:

- Topic Area 1 Mathematics
- Topic Area 2 Mechanical principles
- Topic Area 3 Electrical/electronic principles

- **F132: Engineering in practice**

This unit is assessed by an assignment.

In this unit you will analyse products, produce engineering CAD drawings and make a component and a circuit prototype. Topics include:

- Topic Area 1 Product analysis
- Topic Area 2 Produce Computer Aided Design (CAD) mechanical and electronic engineering drawings
- Topic Area 3 Plan the safe manufacture of a mechanical prototype and an electronic circuit prototype
- Topic Area 4 Manufacturing processes
- Topic Area 5 Evaluate a prototype

### **The subjects that complement this course**

These A Level might complement this qualification:

- Mathematics
- Physics
- Computer Science

### **The types of courses you may progress to**

Both the subject-specific knowledge, understanding and skills, and broader transferable skills developed through these units, will help you progress to further study in related areas such as:

- BEng (Hons) Mechanical Engineering
- BEng (Hons) Manufacturing Engineering
- BEng (Hons) Mechanical and Manufacturing Engineering
- BEng (Hons) Electronic Engineering
- BEng (Hons) Electrical and Electronic Engineering

## Why you should take the OCR Level 3 Cambridge Advanced National (AAQ) in Engineering (Certificate)

There are two qualifications available in Engineering. These are:

OCR Level 3 Cambridge Advanced National (AAQ) in Engineering (Certificate) – this is 180 GLH in size.

OCR Level 3 Cambridge Advanced National (AAQ) in Engineering (Extended Certificate) – this is 360 GLH in size.

You should take this Certificate qualification if you want a small Level 3 qualification that builds some applied knowledge and skills in engineering. This qualification is an Alternative Academic Qualification (AAQ) that is the same size as an AS Level qualification. It is half the size of an A Level. It could be taken alongside A Levels to help enhance your learning as it will complement A Levels, helping you to build broader knowledge and skills that are valued in undergraduate study, and relevant for progression to higher education. You would take this qualification alongside A Levels as part of your programme of study at Key Stage 5.

### More information

More information about the OCR Level 3 Cambridge Advanced National (AAQ) in Engineering (Certificate) is in these documents:

- Specification: <<insert link>>
- Sample Assessment Material (SAM) Question Papers:
  - Unit 1: <<insert link>>
- Guides to our SAM Question Papers:
  - Unit 1: <<insert link>>
- SAM Set assignment(s):
  - Unit 3: <<insert link>>
- Student Guide to NEA Assignments: <<insert link>>



## 2.5 Purpose statement – Extended Certificate



Oxford Cambridge and RSA

OCR Level 3 Cambridge Advanced National (AAQ) in Engineering (Extended Certificate)

Qualification number: TBC

### Overview

#### Who this qualification is for

The OCR Level 3 Cambridge Advanced National (AAQ) in Engineering (Extended Certificate) is for students aged 16-19 years old. It will develop knowledge, understanding and skills that will help prepare you for progression to undergraduate study and are relevant to the engineering sector.

You might be interested in this qualification if you want to apply what you learn to practical, real-life contexts, such as:

- Recreating physical products as a 3D model.
- Assembling, testing and programming electronic devices.
- Disassembling a product to investigate how it works.

The qualification will also help you develop independence and confidence in using skills that are relevant to the sector and that prepare you for progressing to university courses where independent study skills are needed. You will develop the following transferable skills that can be used in both higher education and other life and work situations:

- Safe working practices. Safety always comes first in engineering. Working safely requires good planning skills and the ability to manage both resources and time effectively.
- Communicating effectively with individuals or groups. Communication is important for engineers to ensure that ideas and solutions can be shared and understood by others.
- Using thinking and problem-solving skills in order to identify solutions and improvements.
- Project-based skills. Engineers often work as part of a wider team to ensure that projects are completed.

This qualification will complement other learning that you're completing at Key Stage 5. If you are a full-time student, it will be part of your studies along with A Levels.

#### What you will study when you take this qualification

Through a combination of theoretical study and hands-on experience, you will develop the necessary knowledge and skills that can support progression to higher education engineering study.

In the examined units, you will study key knowledge and understanding relevant to engineering. In the non examined assessment (NEA) units, you will demonstrate knowledge and skills you learn by completing applied or practical assignments. More information about the knowledge and skills you will develop is below.

The qualification has three mandatory units and six optional units. You must choose two of the optional units.

These are the **mandatory** units – you must take **all** of these units:

- F130: Principles of engineering

This unit is assessed by an exam.

In this unit you will learn about the mathematical techniques, forces and the electrical/electronic principles widely used in the engineering industry. Topics include:

- Topic Area 1 Mathematics
- Topic Area 2 Mechanical principles
- Topic Area 3 Electrical/electronic principles

- F131: Materials science and technology

This unit is assessed by an exam.

In this unit you will learn about different material properties, the types of material and their relative properties, and how these properties can be affected by different processing techniques. Topics include:

- Topic Area 1 Material properties
- Topic Area 2 Types of material
- Topic Area 3 Effect of processing techniques on material properties
- Topic Area 4 Material failure mechanisms and prevention
- Topic Area 5 Sustainable materials and practices in engineering

- F132: Engineering in practice

This unit is assessed by an assignment.

In this unit you will analyse products, produce engineering CAD drawings and make a component and a circuit prototype. Topics include:

- Topic Area 1 Product analysis
- Topic Area 2 Produce Computer Aided Design (CAD) mechanical and electronic engineering drawings
- Topic Area 3 Plan the safe manufacture of mechanical prototype and an electronic circuit prototype
- Topic Area 4 Manufacturing processes
- Topic Area 5 Evaluate a prototype

These are **optional** units – you must take **two** of these units:

- F133: Computer Aided Design (CAD)

This unit is assessed by an assignment.

In this unit you will create a 3D model of an object, make changes to the design and carry out simulations. Topics include:

- Topic Area 1 Produce 3D models using Computer Aided Design (CAD)
- Topic Area 2 Create a 3D assembly of multiple components within a CAD software
- Topic Area 3 Creating technical drawings from 3D models
- Topic Area 4 Simulations in 3D modelling

- F134: Programmable electronics

This unit is assessed by an assignment.

In this unit you will use input and output devices and produce representations of them in different types of programmable electronic devices. Topics include:

- Topic Area 1 Microcontrollers and microcontroller systems
- Topic Area 2 Using input and output devices and other electronic components in microcontroller systems
- Topic Area 3 Designing, developing, and assembling microcontroller-based programmable systems
- Topic Area 4 Programming microcontrollers

- F135: Mechanical product design

This unit is assessed by an assignment.

In this unit you will analyse and disassemble existing products safely to unlock their design secrets and investigate how to redesign them. Topics include:

- Topic Area 1 Product analysis
- Topic Area 2 Product redesign

- F136: Computer Aided Manufacturing (CAM)

This unit is assessed by an assignment.

In this unit you will use Computer Numerical Control (CNC) machines and CAD/CAM to manufacture a component. Topics include:

- Topic Area 1 Subtractive and additive Computer Aided Manufacturing (CAM) processes
- Topic Area 2 Three dimensional (3D) Computer Aided Design (CAD) modelling of prototype components
- Topic Area 3 Manufacturing prototype components using subtractive processes
- Topic Area 4 Manufacturing prototype components using additive processes
- Topic Area 5 Evaluating prototype components manufactured using subtractive and additive manufacturing processes

- F137: Electrical devices and circuits

This unit is assessed by an assignment.

In this unit you will use circuit theory and fundamental electronics to design, build and test electronic circuits. Topics include:

- Topic Area 1 Power sources
- Topic Area 2 Semiconductor devices
- Topic Area 3 Analogue circuits
- Topic Area 4 Digital circuits

- F138: Mathematics for engineering

This unit is assessed by an exam.

In this unit you will learn about a range of mathematical concepts and deepen your understanding of statistics, exponentials, and trigonometry, by applying them to engineering contexts. Topics include:

- Topic Area 1 Matrices and determinants
- Topic Area 2 Differential calculus
- Topic Area 3 Integral calculus
- Topic Area 4 Statistics and probability
- Topic Area 5 Indices, exponentials and logarithms

### **The subjects that complement this course**

These A Level subjects might complement this qualification:

- Mathematics
- Physics
- Computer Science

### **The types of courses you may progress to**

Both the subject-specific knowledge, understanding and skills, and broader transferable skills developed through these units, will help you progress to further study in related areas such as:

- BEng (Hons) Mechanical Engineering
- BEng (Hons) Manufacturing Engineering
- BEng (Hons) Mechanical and Manufacturing Engineering
- BEng (Hons) Electronic Engineering
- BEng (Hons) Electrical and Electronic Engineering

## Why you should take the OCR Level 3 Cambridge Advanced National (AAQ) in Engineering (Extended Certificate)

There are two qualifications available in Engineering. These are:

OCR Level 3 Cambridge Advanced National (AAQ) in Engineering (Certificate) – this is 180 GLH in size.

OCR Level 3 Cambridge Advanced National (AAQ) in Engineering (Extended Certificate) – this is 360 GLH in size.

You should take this Extended Certificate qualification if you want a Level 3 qualification that builds applied knowledge and skills in engineering. This qualification is an Alternative Academic Qualification (AAQ) that is the same size as an A Level. When it is taken alongside A Levels it will complement them, helping you to build broader knowledge and skills that are valued in undergraduate study, and relevant for progression to higher education. You would take this qualification alongside A Levels as part of your programme of study at Key Stage 5.

### More information

More information about the OCR Level 3 Cambridge Advanced National (AAQ) in Engineering (Extended Certificate) is in these documents:

- Specification: <<insert link>>
- Sample Assessment Material (SAM) Question Papers:
  - Unit 1: <<insert link>>
  - Unit 2: <<insert link>>
  - Unit 9: <<insert link>>
- Guides to our SAM Question Papers:
  - Unit 1: <<insert link>>
  - Unit 2: <<insert link>>
  - Unit 9: <<insert link>>
- SAM Set assignment(s):
  - Unit 3: <<insert link>>
  - Unit 4: <<insert link>>
  - Unit 5: <<insert link>>
  - Unit 6: <<insert link>>
  - Unit 7: <<insert link>>
  - Unit 8: <<insert link>>
- Student Guide to NEA Assignments: <<insert link>>

## 3 About these qualifications

### 3.1 Qualification size

The size of each qualification is described in terms of Guided Learning Hours (GLH) and Total Qualification Time (TQT).

GLH indicates the approximate time (in hours) you will spend supervising or directing study and assessment activities. We have worked with people who are experienced in delivering related qualifications to determine the content that needs to be taught and how long it will take to deliver.

TQT includes two parts:

- GLH
- an estimate of the number of hours a student will spend on unsupervised learning or assessment activities (including homework) to successfully complete their qualification.

The OCR Level 3 Cambridge Advanced National (AAQ) in Engineering (Certificate) is 180 GLH and 230 TQT.

The OCR Level 3 Cambridge Advanced National (AAQ) in Engineering (Extended Certificate) is 360 GLH and 480 TQT.

### 3.2 Availability and language

The Level 3 Cambridge Advanced Nationals (AAQs) are available in England only. They are **not** available in Wales or Northern Ireland.

The qualifications and their assessment materials are available in English only. We will only assess answers written in English.

### 3.3 Prior knowledge and experience

Recognition of prior learning (RPL) is the process for recognising learning that never received formal recognition through a qualification or certification. It includes knowledge and skills gained in school, college or outside of formal learning situations. These may include:

- domestic/family life
- education
- training
- work activities
- voluntary activities.

In most cases RPL will not be appropriate for directly evidencing the requirements of the NEA assignments for the Cambridge Advanced Nationals (AAQs) qualifications. However, if you feel that your student could use RPL to support their evidence, you must follow the guidance provided in our **RPL Policy**.

## 4 Units

### 4.1 Guidance on unit content

This section describes what must be taught so that students can access all available marks and meet assessment criteria.

#### 4.1.1 Externally assessed units (F130, F131 and F138)

The externally assessed units contain a number of topic areas.

For each topic area, we list the **teaching content** that must be taught and give information on the **breadth and depth** of teaching needed.

#### Teaching content

A direct question can be asked about any content in the teaching content column.

#### Breadth and depth

The breadth and depth column:

- clarifies the breadth and depth of teaching needed
- indicates the range of knowledge and understanding that can be assessed in the exam
- confirms any aspects that you do not need to teach as 'does not include' statements.

Teaching must cover **both** the **teaching content** and **breadth and depth** columns.

#### Knowledge and understanding

This is what we mean by knowledge and understanding:

Knowledge	<ul style="list-style-type: none"><li>• Be able to identify or recognise an item, for example on a diagram.</li><li>• Use direct recall to answer a question, for example the definition of a term.</li></ul>
Understanding	<ul style="list-style-type: none"><li>• To assess and evidence the perceived meaning of something in greater depth than straight identification or recall.</li><li>• Understanding will be expressed and presented using terms such as: how; why; when; reasons for; advantages and disadvantages of; benefits and limitations of; purpose of; suitability of; recommendations for improvement; appropriateness of something to/in different contexts.</li></ul>

Students will need to **understand** the content, unless the breadth and depth column identifies it as knowledge only.

Any item(s) that should be taught as **knowledge** only will start with the word 'know' in the breadth and depth column.

All other content must be taught as understanding.

#### 4.1.2 NEA units (F132 – F137)

The NEA units contain a number of topic areas.

For each topic area, we list **teaching content** that must be taught and give **exemplification**. The exemplification shows the teaching expected to equip students to successfully complete their assignments.

#### 4.1.3 Command words

**Appendix B** gives information about the command words that will be used in the external assessments and the NEA assessment criteria.

#### 4.1.4 Performance objectives (POs):

Each Cambridge Advanced National (AAQ) qualification has four Performance Objectives.

PO1	Show knowledge and understanding
PO2	Apply knowledge and understanding
PO3	Analyse and evaluate knowledge, understanding and performance
PO4	Demonstrate and apply skills and processes relevant to the subject

PO1 is assessed in the externally assessed unit only.

PO4 is assessed in the NEA units only.

The weightings of the Performance Objectives across the units in the **Certificate** qualification are:

Performance Objective	Externally Assessed unit (range)	NEA unit	Overall weighting
PO1	12.5-25%	n/a	12.5-25%
PO2	12.5-25%	8.9%	21.4-33.9%
PO3	6.25-12.5%	10.7%	16.95-23.2%
PO4	n/a	30.4%	30.4%
<b>Overall weighting of assessments</b>	<b>50%</b>	<b>50%</b>	<b>100%</b>

The weightings of the Performance Objectives across the units in the **Extended Certificate** qualification are:

Performance Objective	Externally Assessed unit (range)	NEA units	Overall weighting
PO1	10-30%	n/a	10-30%
PO2	10-30%	6.7-15%	16.7-45%
PO3	5-15%	6.7-16.7%	11.7-31.7%
PO4	n/a	20-38.3%	20-38.3%
<b>Overall weighting of assessments</b>	<b>40-58%</b>	<b>60%</b>	<b>100%</b>



## 4.2 Externally assessed units

### 4.2.1 Unit F130: Principles of engineering

#### Unit aim

Every engineering system or product is underpinned by fundamental engineering principles. These principles will be carefully applied to meet a variety of needs, such as the physical properties of the engineered solution, the forces involved in the use of the product or system, and the electrical/electronic properties and requirements of the system or product. This unit provides you with the opportunity to gain knowledge and understanding of the principles of operation of mechanical and electrical/electronic elements of engineering systems. You will understand how mechanical and electrical/electronic principles can be used to solve engineering problems.

In this unit you will learn about static and dynamic forces in a range of engineering contexts. You will learn about electrical/electronic principles, through direct and alternative current applications, analogue and digital systems as well as programmable systems and electrical efficiency. Through the calculation of various mechanical and electrical/electronic properties in given scenarios, you will also learn the necessary mathematical techniques used in the engineering industry.

Unit F130: Principles of engineering	
Topic Area 1: Mathematics	
Teaching content	Breadth and depth
<b>1.1 Application of Système International (SI) Units</b>	
<ul style="list-style-type: none"> <li>□ Base SI Units relevant to engineering principles:               <ul style="list-style-type: none"> <li>• Ampere for electric current</li> <li>• Kilogram for mass</li> <li>• Metre for length</li> <li>• Second for time</li> </ul> </li> <li>□ Deriving SI units for the subject of an equation</li> <li>□ SI prefixes G, M, k, m, <math>\mu</math>, n, p</li> <li>□ Engineering notation and its relationship to SI prefixes</li> <li>□ Scientific notation</li> <li>□ Use of scientific and engineering notation in calculations on a scientific calculator</li> <li>□ Converting between metric units of measure</li> </ul>	<p>To include:</p> <ul style="list-style-type: none"> <li>□ Units for all quantities listed in the content of the unit</li> <li>□ Deriving units for all equations listed in the content of the unit</li> <li>□ Converting engineering notation to scientific notation and vice versa</li> <li>□ Converting engineering notation to SI prefixes and vice versa</li> </ul> <p>Does not include:</p> <ul style="list-style-type: none"> <li>□ SI base units kelvin, candela, and mole</li> </ul>
<b>1.2 Mensuration</b>	
<ul style="list-style-type: none"> <li>□ Calculation of perimeter and area of regular and compound 2D shapes:               <ul style="list-style-type: none"> <li>• Circle, where <math>r</math> is the radius and <math>d</math> is the diameter:                   <ul style="list-style-type: none"> <li>○ <math>Area = \pi r^2</math> or <math>= \frac{\pi}{4} d^2</math></li> <li>○ <math>Circumference = 2\pi r</math> or <math>= \pi d</math></li> </ul> </li> <li>• Rectangle, where <math>l</math> is the length and <math>h</math> is the height:                   <ul style="list-style-type: none"> <li>○ <math>Area = lh</math></li> <li>○ <math>Perimeter = 2l + 2h</math></li> </ul> </li> </ul> </li> </ul>	<p>To include:</p> <ul style="list-style-type: none"> <li>□ Compound 2D shapes made by addition or subtraction of standard 2D shapes</li> <li>□ Compound 3D solids made by addition or subtraction of standard 3D solids</li> <li>□ Know how to use Pi (<math>\pi</math>) on a calculator</li> <li>□ Know that mass is a measure of the amount of matter an object is made out of</li> </ul>

<ul style="list-style-type: none"> <li>• Triangle, where <math>b</math> is the base, <math>h</math> is the height and <math>c</math> is a side: <ul style="list-style-type: none"> <li>○ Area = <math>\frac{1}{2}bh</math> or = <math>\frac{1}{2}bc \sin A</math></li> <li>○ Perimeter = <math>a + b + c</math></li> </ul> </li> <li>□ Calculation of surface areas and volumes of regular and compound 3D solids: <ul style="list-style-type: none"> <li>• Cylinder <ul style="list-style-type: none"> <li>○ Curved surface area = <math>2\pi rh</math></li> <li>○ Total surface area = <math>2\pi r^2 + 2\pi rh</math></li> <li>○ Volume = <math>\pi r^2 h</math></li> </ul> </li> <li>• Sphere <ul style="list-style-type: none"> <li>○ Surface Area = <math>4\pi r^2</math></li> <li>○ Volume = <math>\frac{4}{3}\pi r^3</math></li> </ul> </li> <li>• Cone <ul style="list-style-type: none"> <li>○ Curved surface area = <math>\pi rl</math></li> <li>○ Total surface area = <math>\pi r^2 + \pi rl</math></li> <li>○ Volume = <math>\frac{1}{3}\pi r^2 h</math></li> </ul> </li> </ul> </li> <li>□ Calculation of the mass of a body of known volume and uniform density: Density <math>\rho = \frac{m}{v}</math>, where <math>m</math> is mass and <math>v</math> is volume</li> </ul>	
<h3>1.3 Algebra</h3>	
<ul style="list-style-type: none"> <li>□ Simplify, rearrange, and solve engineering equations</li> <li>□ Common logarithms (base 10)</li> <li>□ Straight lines: <ul style="list-style-type: none"> <li>• Equation <math>y = mx + c</math></li> <li>• Where gradient <math>m = \frac{\Delta y}{\Delta x}</math> and the intercept is (<math>c</math>)</li> <li>• Interpreting cartesian straight-line graphs</li> </ul> </li> <li>□ Multiply expressions in brackets by a number or symbol</li> <li>□ Multiplying brackets</li> <li>□ Simple factorisation</li> <li>□ Simultaneous equations</li> </ul>	<p>To include:</p> <ul style="list-style-type: none"> <li>□ Rearranging given mechanical engineering formulae and electrical/electronic formulae</li> <li>□ Common factors for simple factorisation</li> <li>□ Solving pairs of simultaneous linear equations with two unknowns using an algebraic method</li> </ul> <p>Does not include:</p> <ul style="list-style-type: none"> <li>□ Laws of logarithms and indices</li> <li>□ Natural logarithms (base <math>e</math>)</li> <li>□ Exponential growth and decay</li> <li>□ Quadratics or quadratic equations</li> </ul>
<h3>1.4 Trigonometry</h3>	
<ul style="list-style-type: none"> <li>□ Trigonometric ratios <ul style="list-style-type: none"> <li>• <math>\sin \theta = \frac{opp}{hyp}</math></li> <li>• <math>\cos \theta = \frac{adj}{hyp}</math></li> <li>• <math>\tan \theta = \frac{opp}{adj}</math></li> </ul> </li> <li>□ Periodic properties of the trigonometric functions</li> </ul>	<p>To include:</p> <ul style="list-style-type: none"> <li>□ Graphs of sine, cosine and tangent trigonometric functions over one complete cycle</li> <li>□ Using a scientific calculator to find values of the trigonometric functions</li> <li>□ Conversion of radians to degrees and vice versa</li> </ul>

<ul style="list-style-type: none"> <li>□ Pythagoras' rule: <math>hyp^2 = opp^2 + adj^2</math></li> <li>□ Radian unit of measure <ul style="list-style-type: none"> <li>• Converting radians into degrees: <math display="block">degrees = radians \times \frac{180}{\pi}</math> </li> <li>• Converting degrees into radians <math display="block">radians = degrees \times \frac{\pi}{180}</math> </li> </ul> </li> <li>□ Sine rule <ul style="list-style-type: none"> <li>• <math>\frac{\sin A}{a} = \frac{\sin B}{b} = \frac{\sin C}{c}</math></li> </ul> </li> <li>□ Cosine rule <ul style="list-style-type: none"> <li>• <math>a^2 = b^2 + c^2 - 2bc \cos A</math></li> <li>• <math>b^2 = a^2 + c^2 - 2ac \cos B</math></li> <li>• <math>c^2 = b^2 + a^2 - 2ab \cos C</math></li> </ul> </li> </ul>	<ul style="list-style-type: none"> <li>□ Using radians on a scientific calculator</li> </ul> <p>Does not include:</p> <ul style="list-style-type: none"> <li>□ Vectors</li> <li>□ Phasors</li> </ul>
<b>Topic Area 2: Mechanical principles</b>	
<b>2.1 Systems of forces</b>	
<p><b>2.1.1 Forces</b></p> <ul style="list-style-type: none"> <li>□ Definition of a force as an external agent capable of changing a body's state of rest or motion</li> <li>□ Definition of the Newton (N) as the force required to cause a mass 1 kg to accelerate at <math>1 \text{ ms}^{-2}</math></li> <li>□ Defining a force vector using magnitude, direction and sense</li> <li>□ Graphical representation of a force vector</li> </ul>	<p>To include:</p> <ul style="list-style-type: none"> <li>□ Analysis of systems with up to five forces</li> <li>□ Simple systems of forces containing two forces</li> <li>□ Complex systems of forces containing up to five forces</li> </ul>
<p><b>2.1.2 Moments</b></p> <ul style="list-style-type: none"> <li>□ The turning effect of forces <ul style="list-style-type: none"> <li>• Moment <math>M = Fd</math></li> </ul> </li> </ul>	
<p><b>2.1.3 Systems of coplanar concurrent forces</b></p> <ul style="list-style-type: none"> <li>□ Concurrent forces act on a particle with the line of action of all forces passing through a single point</li> <li>□ Using a free body diagram to represent a complex system of forces</li> <li>□ Using graphical representation of simple systems of forces: <ul style="list-style-type: none"> <li>• Vector diagrams</li> <li>• Triangle of forces</li> <li>• Parallelogram of forces</li> </ul> </li> <li>□ Calculating the resultant of two perpendicular forces using: <ul style="list-style-type: none"> <li>• Scale drawing</li> <li>• Trigonometry</li> <li>• Pythagoras</li> </ul> </li> </ul>	

- Calculating the resultant of two non-perpendicular forces using:
  - Scale drawing
  - Sine rule
  - Cosine rule
- Resolving a force into horizontal and vertical components:
  - Vertical component  $F_v = F \sin \theta$ ,  $\theta$  from the horizontal
  - Horizontal component  $F_h = F \cos \theta$ ,  $\theta$  from the horizontal
  - Resultant  $F_R = \sqrt{\sum F_v^2 + \sum F_h^2}$
- Simplification of complex systems of forces by the summation of vertical and horizontal components
- Calculating the resultant of a complex systems of forces
- Conditions of equilibrium:
  - $\sum f_v = 0$
  - $\sum f_h = 0$
- Using the resultant of a system of forces to find the equilibrant
- Fully defining the resultant and equilibrant of a concurrent system of forces by stating:
  - Magnitude
  - Direction
  - Sense

### 2.1.4 Systems of coplanar non-concurrent forces in equilibrium

- Non-concurrent forces act on a rigid body where the line of action of all forces do not pass through a single point
- Free body diagrams of complex systems of forces acting on a rigid body including dimensions defining the distance from their lines of action to a fixed point
- Calculating the resultant of a complex systems of forces
- Calculating the resultant turning moment around a fixed point
- Conditions of equilibrium:
  - $\sum f_v = 0$
  - $\sum f_h = 0$
  - $\sum M = 0$
- Using the resultant of a system of forces to find the equilibrant
- Fully defining the resultant and equilibrant of a non-concurrent system of forces by stating:
  - Magnitude
  - Direction
  - Sense
  - Perpendicular distance from the line of action to a fixed point

### 2.1.5 Direct loading of engineering components

- Direct forces act in:
  - Tension
  - Compression
- Calculations involving:
  - Direct tensile or compressive stress
$$\sigma = \frac{F}{A}$$
  - Direct tensile or compressive strain
$$\varepsilon = \frac{\Delta L}{L}$$
  - Modulus of elasticity or Young's modulus
$$E = \frac{\sigma}{\varepsilon}$$
- Use formulae in calculations involving elastic behaviour of components in direct tension or compression

<p><b>2.1.6 Shear loading of engineering components</b></p> <ul style="list-style-type: none"> <li>□ Calculations involving: <ul style="list-style-type: none"> <li>• Shear stress <math>\tau = \frac{F}{A}</math></li> <li>• Shear strain <math>\gamma = \frac{\Delta L}{L}</math></li> <li>• Modulus of rigidity <math>G = \frac{\tau}{\gamma}</math></li> </ul> </li> <li>□ Solving problems involving single and double shear</li> </ul>	
<p><b>2.1.7 Stress vs strain graphs</b></p> <ul style="list-style-type: none"> <li>□ Use of stress vs strain graphs to analyse the behaviour of a material under load <ul style="list-style-type: none"> <li>• Elastic deformation</li> </ul> </li> <li>□ Calculation of modulus of elasticity/Young's modulus from the gradient of the straight-line section of the graph</li> </ul>	<p>Does not include:</p> <ul style="list-style-type: none"> <li>□ Plastic deformation above the elastic limit</li> </ul>
<p><b>2.2 Simply supported beams</b></p>	
<p><b>2.2.1 Beams and beam supports</b></p> <ul style="list-style-type: none"> <li>□ Simply supported horizontal beams supported at either end</li> <li>□ Beam supports including: <ul style="list-style-type: none"> <li>• Roller support with free rotation and free horizontal movement providing a vertical support reaction perpendicular to the beam</li> <li>• Pinned support with free rotation providing support reaction with vertical and horizontal components</li> </ul> </li> </ul>	<p>Does not include:</p> <ul style="list-style-type: none"> <li>□ Beams that overhang supports</li> </ul>
<p><b>2.2.2 Forces acting on beams</b></p> <ul style="list-style-type: none"> <li>□ Point loads: <ul style="list-style-type: none"> <li>• Loads acting vertically downwards</li> <li>• Loads acting at an angle (with horizontal and vertical components)</li> </ul> </li> <li>□ Uniformly distributed load (UDL): <ul style="list-style-type: none"> <li>• Dead loads from the weight of the beam that act along the full length of the beam</li> <li>• Imposed loads that act over a defined section of the beam</li> <li>• Calculated magnitude and position of a single point load equivalent to a UDL</li> </ul> </li> <li>□ Draw free body diagrams of simply supported beams</li> </ul>	

<p><b>2.2.3 Beam calculations</b></p> <ul style="list-style-type: none"> <li>□ Conditions for static equilibrium of simply supported beams with roller supports <ul style="list-style-type: none"> <li>• <math>\sum f_v = 0</math></li> <li>• <math>\sum M = 0</math></li> </ul> </li> <li>□ Conditions for static equilibrium of simply supported beams with one roller and one pinned support <ul style="list-style-type: none"> <li>• <math>\sum f_v = 0</math></li> <li>• <math>\sum f_h = 0</math></li> <li>• <math>\sum M = 0</math></li> </ul> </li> <li>□ Calculating vertical support reaction forces by taking moments about the other support</li> <li>□ Calculating horizontal support reactions where there are pinned supports</li> <li>□ Calculation of bending moments at any point along a simply supported beam with point loading</li> </ul>	<p>To include:</p> <ul style="list-style-type: none"> <li>□ Beams with one roller and one pinned support with loads having both vertical and horizontal components</li> <li>□ Checking calculations to show that sum of support reactions equals sum of beam loads</li> <li>□ Beam with max 4-point loads and 2 Uniformly Distributed Loads (UDL)</li> </ul> <p>Does not include:</p> <ul style="list-style-type: none"> <li>□ Calculating bending moments along beams with uniformly distributed loads</li> </ul>
<p><b>2.2.4 Bending moment diagrams</b></p> <ul style="list-style-type: none"> <li>□ Drawing a bending moment diagram for a simply supported beam with point loading</li> </ul>	
<p><b>2.3 Linear dynamic systems</b></p>	
<p><b>2.3.1 Parameters and applications</b></p> <ul style="list-style-type: none"> <li>□ Parameters: <ul style="list-style-type: none"> <li>• Acceleration is rate of change of velocity</li> <li>• Displacement is the straight-line distance between two points in a given direction</li> <li>• Velocity is the rate of change in displacement</li> </ul> </li> <li>□ Applications of linear dynamic systems</li> </ul>	<p>To include:</p> <ul style="list-style-type: none"> <li>□ Applications of linear dynamic systems involving: <ul style="list-style-type: none"> <li>• Linear motion</li> <li>• Collisions</li> <li>• Projectiles</li> <li>• Inclined planes</li> <li>• Lifting using single pulleys</li> </ul> </li> </ul>
<p><b>2.3.2 Interpretation of graphs</b></p> <ul style="list-style-type: none"> <li>□ Displacement vs time graphs <ul style="list-style-type: none"> <li>• Gradient is velocity</li> </ul> </li> <li>□ Velocity vs time graphs <ul style="list-style-type: none"> <li>• Gradient is acceleration</li> <li>• Area under the graph is displacement</li> </ul> </li> </ul>	<p>To include:</p> <ul style="list-style-type: none"> <li>□ Systems with constant acceleration only</li> </ul>
<p><b>2.3.3 Newton's Laws of Motion</b></p> <ul style="list-style-type: none"> <li>□ Newton's Laws: <ul style="list-style-type: none"> <li>• First law - A body continues in a state of uniform rest or motion unless acted upon by an external force</li> <li>• Second law - The acceleration produced by a force is directly proportional to the force and occurs in the same direction as the force acts</li> <li>• Third law - To every action there is an equal and opposite reaction</li> </ul> </li> </ul>	<p>To include:</p> <ul style="list-style-type: none"> <li>□ Acceleration due to gravity (<math>g</math>) is the acceleration of an object in free fall within a vacuum (<math>g = 9.81 \text{ ms}^{-2}</math>)</li> </ul>

<ul style="list-style-type: none"> <li>□ Application of Newton's Laws of motion in mechanical engineering contexts</li> <li>□ Calculation involving: <ul style="list-style-type: none"> <li>• <math>Force = mass \times acceleration</math> <math>F = ma</math></li> <li>• <math>Weight = mass \times acceleration\ due\ to\ gravity</math> <math>W = mg</math></li> </ul> </li> </ul>	
<p><b>2.3.4 Displacement (S), initial velocity (U), final velocity (V), acceleration (A), Time (T) (SUVAT) Equations</b></p> <ul style="list-style-type: none"> <li>□ Application of SUVAT equations for uniformly accelerated motion in a straight line <ul style="list-style-type: none"> <li>• <math>v = u + at</math></li> <li>• <math>v^2 = u^2 + 2as</math></li> <li>• <math>s = ut + \frac{1}{2}at^2</math></li> <li>• <math>s = \frac{1}{2}(u + v)t</math></li> </ul> </li> </ul>	<p>To include:</p> <ul style="list-style-type: none"> <li>□ Objects moving with different start and end conditions</li> </ul>
<p><b>2.3.5 Energy and power</b></p> <ul style="list-style-type: none"> <li>□ Calculations involving: <ul style="list-style-type: none"> <li>• Work done <math>W = Fd</math></li> <li>• Gravitational potential energy <math>E_p = mgh</math></li> <li>• Kinetic energy <math>E_k = \frac{1}{2}mv^2</math></li> <li>• Average power <math>P = \frac{W}{t}</math></li> <li>• Instantaneous power <math>P = Fv</math></li> <li>• Energy efficiency <math>\eta = \frac{E_{out}}{E_{in}} \times 100\%</math></li> </ul> </li> </ul>	
<p><b>2.3.6 Friction</b></p> <ul style="list-style-type: none"> <li>□ Calculations involving: <ul style="list-style-type: none"> <li>• Static friction <math>F \leq \mu N</math></li> <li>• Dynamic friction</li> </ul> </li> </ul>	
<p><b>2.3.7 Conservation of energy</b></p> <ul style="list-style-type: none"> <li>□ Application of the principle of conservation of energy</li> </ul>	<p>To include:</p> <ul style="list-style-type: none"> <li>□ Applications to systems involving gravitational potential energy, kinetic energy, friction and work done</li> </ul>
<p><b>2.3.8 Momentum</b></p> <ul style="list-style-type: none"> <li>□ Calculations involving <ul style="list-style-type: none"> <li>• Momentum <math>p = mv</math></li> </ul> </li> <li>□ Application of the principles of conservation of momentum in: <ul style="list-style-type: none"> <li>• Collisions between two bodies <math>m_1u_1 + m_2u_2 = m_1v_1 + m_2v_2</math></li> <li>• Perfectly inelastic collisions between two bodies <math>m_1u = (m_1 + m_2)v</math></li> </ul> </li> </ul>	



## Topic Area 3: Electrical/electronic principles

### 3.1 Electrical principles

#### 3.1.1 Concepts of electricity

- Atomic structure and electric current
- Electron flow and current flow in conductors, semi-conductors and insulators
- The term Coulomb, the abbreviation for charge ( $Q$ ) and use of the formula for charge  $Q = It$
- Potential difference/Voltage ( $V$ ) relating to electrical energy and charge  $E = QV$
- Use of the formulae for electrical energy  $E = Pt$
- Definition of direct current (DC)
- Types of DC power source:
  - Cells
  - Batteries
  - Stabilised power supply
  - How to choose the correct type of DC power source for a given application
- The term resistivity and use of the formula for resistivity  $\rho = \frac{RA}{l}$
- Current-potential difference characteristics for:
  - a metallic conductor at constant temperature of a given resistance
  - a filament lamp
- The function of a resistor in a circuit and why they are used
- Ohm's Law  $R = \frac{V}{I}$  and its use in series and parallel resistor circuits
- Equivalent total resistance of series resistors  
 $R_T = R_1 + R_2 + R_3 \dots$
- Equivalent total resistance of parallel resistors  $\frac{1}{R_T} = \frac{1}{R_1} + \frac{1}{R_2} + \frac{1}{R_3} \dots$
- Use of the formulae for electrical power  
 $P = I^2R$ ,  $P = VI$  and  $P = \frac{V^2}{R}$

To include:

- Circuit symbol and abbreviation for each component
- Interpreting circuit diagrams containing relevant components

Does not include:

- Temperature coefficients
- Component level circuit design of power supplies

#### 3.1.2 Capacitors and capacitance

- The function of a capacitor in a circuit and why they are used
- Use of the formula for capacitance  
 $C = \epsilon \frac{A}{d}$  to show how parallel plates form a capacitor, where  $\epsilon$  is the permittivity
- Use of a dielectric  $C = \epsilon_0 \epsilon_r \frac{A}{d}$

To include:

- Circuit symbols for polarised and non-polarised capacitor and abbreviation
- Interpreting circuit diagrams containing relevant components
- Know that permittivity  $\epsilon = \epsilon_0 \times \epsilon_r$
- Permittivity of free space  $\epsilon_0 = 8.85 \times 10^{-12} \text{ F m}^{-1}$

<ul style="list-style-type: none"> <li>□ The terms capacitance (C) and farad (F)</li> <li>□ The relationship between capacitance and energy stored in a capacitor <math>C = QV</math> and <math>E = \frac{1}{2}CV^2</math></li> <li>□ How to draw a graph for a capacitor discharging through a resistor of <ul style="list-style-type: none"> <li>• Potential difference against time</li> <li>• Current against time</li> </ul> </li> <li>□ The significance of a time constant for the discharge of a capacitor and use of the formula for time constant <math>\tau = RC</math></li> <li>□ Use of the formula for the discharge of a capacitor</li> </ul>	<ul style="list-style-type: none"> <li>□ Relative permittivity <math>\epsilon_r</math>: <ul style="list-style-type: none"> <li>• Relative permittivity <math>\epsilon_{vacuum} = 1</math></li> <li>• Relative permittivity <math>\epsilon_{air} = 1.0006</math></li> <li>• Relative permittivity <math>\epsilon_{Ceramic} = 25</math></li> </ul> </li> <li>Does not include: <ul style="list-style-type: none"> <li>□ Series and parallel capacitors</li> </ul> </li> </ul>
<p><b>3.1.3 Direct Current (DC) networks</b></p> <ul style="list-style-type: none"> <li>□ DC circuit networks containing resistors and one or two power sources</li> <li>□ Kirchhoff current and voltage laws: <ul style="list-style-type: none"> <li>• For a junction <math>\sum I_{in} = \sum I_{out}</math></li> <li>• For a loop <math>\sum V = 0</math></li> </ul> </li> </ul>	<p>To include:</p> <ul style="list-style-type: none"> <li>□ Calculations of current and voltage in parts of a resistor network having up to five nodes and one or two power supplies</li> </ul>
<p><b>3.1.4 Inductors and inductance</b></p> <ul style="list-style-type: none"> <li>□ The function of an inductor in a circuit and why they are used.</li> <li>□ The terms inductance (L) and the unit of inductance - henry (H)</li> <li>□ Use of the formula for the inductance of a coil <math>L = \frac{\Phi N}{I}</math></li> <li>□ Formula for energy stored in the magnetic field of a coil <math>E = \frac{1}{2}LI^2</math></li> <li>□ Force on conductor in a field <math>F = BIl \sin \theta</math>, where: <ul style="list-style-type: none"> <li>• F = force (N),</li> <li>• B = magnetic flux density of external field (T)</li> <li>• I = current in the conductor (A),</li> <li>• l = length of the conductor (m),</li> <li>• <math>\theta</math> = angle between the conductor and external field (degrees)</li> </ul> </li> <li>□ How the force on a conductor forms movement and how this principle is used to create an electric motor (a device). Use of Fleming's left hand rule</li> <li>□ Current generated in a moving field and how this principle is used to create an electric generator (a device). Use of Fleming's left hand rule</li> </ul>	<p>To include:</p> <ul style="list-style-type: none"> <li>□ Circuit symbol for an inductor and abbreviation.</li> <li>□ Interpreting circuit diagrams containing relevant components.</li> </ul> <p>Does not include:</p> <ul style="list-style-type: none"> <li>□ Calculations regarding motor speed, torque, slip etc.</li> <li>□ Calculations regarding transformer voltages, currents, efficiency</li> </ul>

<p><b>3.1.5 Alternating Current (AC)</b></p> <ul style="list-style-type: none"> <li>□ Diagrammatic representations of AC as a sine wave to include: <ul style="list-style-type: none"> <li>• Frequency (<math>f</math>)</li> <li>• Amplitude (<math>A</math>)</li> <li>• Time period (<math>T</math>)</li> <li>• Peak voltage (<math>V_{PK}</math>).</li> </ul> </li> <li>□ AC voltage waveform <math>v = V_{max} \sin(\omega t)</math>, where angular velocity of the waveform <math>\omega = 2\pi f</math> radians/second</li> <li>□ Frequency <math>f = \frac{1}{T}</math></li> <li>□ Instantaneous voltage and current</li> <li>□ Root-Mean-Square (RMS) Voltage definition – and calculation <math>V_{RMS} = \frac{V_{PK}}{\sqrt{2}}</math></li> <li>□ Purely resistive AC circuits, where impedance (<math>Z</math>) is equivalent to resistance (<math>R</math>). <ul style="list-style-type: none"> <li>• Application of Ohm’s law for AC resistive circuits <math>z = \frac{V}{I}</math></li> <li>• Kirchhoff laws in resistive networks with one power source</li> </ul> </li> </ul>	<p>To include:</p> <ul style="list-style-type: none"> <li>□ Circuit symbol for an AC power source and abbreviation.</li> <li>□ Interpreting circuit diagrams containing relevant components</li> <li>□ Advantages and disadvantages of using of AC compared with DC in electrical systems</li> </ul> <p>Does not include:</p> <ul style="list-style-type: none"> <li>□ Complex notation</li> <li>□ Multiple impedances</li> <li>□ Network analysis of capacitors and inductors</li> <li>□ Phasor diagrams</li> <li>□ Phase difference</li> <li>□ Reactance and impedance of capacitors and inductors</li> </ul>
<p><b>3.1.6 Electrical efficiency</b></p> <ul style="list-style-type: none"> <li>□ Electrical energy allows useful work to be done by electrical components and devices and some energy is also wasted as it dissipates into the surroundings.</li> <li>□ Conservation of energy applied to electrical components and devices.</li> <li>□ Calculation of dissipated power in resistive circuits: <math display="block">P = I^2R \text{ or } P = \frac{V^2}{R}</math> </li> <li>□ The amount of energy that is usefully transferred into work is called efficiency. Energy efficiency is: <math display="block">\eta = \frac{\text{energy output}}{\text{energy input}} \times 100\%</math> </li> <li>□ Use of the kilowatt hour (kWh) as a unit of energy</li> <li>□ Battery capacity expressed in milliamp hours (mAh)</li> <li>□ Effects of waste energy on battery life</li> </ul>	<p>To include:</p> <ul style="list-style-type: none"> <li>□ Useful energy and waste energy within components and devices takes various forms including heat, visible light, infrared radiation, sound or noise, kinetic and electrical.</li> <li>□ Calculation of battery life</li> </ul>

<b>3.2 Analogue and digital circuits</b>	
<p><b>3.2.1 Analogue circuits</b></p> <ul style="list-style-type: none"> <li>□ Definition of an analogue circuit</li> <li>□ Types and applications of analogue circuits</li> <li>□ Calculating amplifier gain/loss in terms of: <ul style="list-style-type: none"> <li>• Voltage <math>A_v = \frac{V_{out}}{V_{in}}</math></li> <li>• Current <math>A_I = \frac{I_{out}}{I_{in}}</math></li> <li>• Power <math>A_P = A_v \times A_I</math></li> </ul> </li> <li>□ Expressing amplifier gain/loss in terms of decibels (dB): <ul style="list-style-type: none"> <li>• Voltage <math>a_v(dB) = 20 \times \text{Log}A_v</math></li> <li>• Current <math>a_I(dB) = 20 \times \text{Log}A_I</math></li> <li>• Power <math>a_P(dB) = 10 \times \text{Log}A_P</math></li> </ul> </li> <li>□ Cascading analogue circuits and calculating resulting gain and loss by multiplying stage gains or adding stage gains if expressed in dB.</li> <li>□ Setting gain of inverting and non-inverting op-amp: <ul style="list-style-type: none"> <li>• Non-inverting Gain (<math>A_v</math>) = <math>1 + \frac{R_1}{R_2}</math></li> <li>• Inverting Gain (<math>A_v</math>) = <math>-\frac{R_1}{R_2}</math></li> </ul> </li> <li>□ Frequency response / bandwidth. Use of -3dB point</li> </ul>	<p>To include:</p> <ul style="list-style-type: none"> <li>□ Use of decibels to illustrate gain/loss</li> <li>□ Use of block diagrams to represent analogue circuits</li> <li>□ Simple op-amp inverting and non-inverting amplifier with resistors to set the gain</li> </ul> <p>Does not include:</p> <ul style="list-style-type: none"> <li>□ Anything further than gain/loss in terms of circuit characteristics and calculations</li> <li>□ Noise</li> </ul>
<p><b>3.2.2 Digital logic circuits</b></p> <ul style="list-style-type: none"> <li>□ Definition of a digital logic circuit with reference to discrete signal levels as opposed varying analogue signals</li> <li>□ Types and applications of digital logic circuits</li> <li>□ Concept of 0 and 1 logic states</li> <li>□ Types of logic gate: AND, OR, NAND, NOR, NOT, XOR</li> <li>□ Individual gate symbols, truth tables and Boolean expression.</li> <li>□ How to construct truth tables from digital logic circuits and how to construct digital logic circuits from truth tables</li> <li>□ How to use Boolean expressions (up to three terms) to draw digital logic circuits and/or compile truth tables</li> </ul>	<p>To include:</p> <ul style="list-style-type: none"> <li>□ Simple applications, including circuit diagrams</li> <li>□ Interpretation of Boolean expressions: <math display="block">Q = A \cdot B</math> <math display="block">Q = \overline{A \cdot B}</math> <math display="block">Q = A + B</math> <math display="block">Q = \overline{A + B}</math> <math display="block">Q = \overline{A}</math> <math display="block">Q = A \oplus B = \overline{A} \cdot B + A \cdot \overline{B}</math> </li> <li>□ Logic circuits containing up to three input (8 inputs logic combinations) and up to five gates in total</li> </ul> <p>Does not include:</p> <ul style="list-style-type: none"> <li>□ Boolean algebra</li> <li>□ De Morgans theorem</li> <li>□ Minimisation of solutions</li> <li>□ Single gate solutions</li> <li>□ Logic families (74xx, 74HCxx)</li> <li>□ State diagrams</li> <li>□ Timing diagrams</li> </ul>

## Assessment guidance

This unit is assessed by an exam. The exam is 1 hour and 30 minutes. It has two Sections – Section A and Section B.

- Section A has 35 marks.
- Section B has 35 marks.
- The exam has 70 marks in total

<b>Section A</b>	<ul style="list-style-type: none"><li>• All questions are compulsory</li><li>• Questions in this section will be based on Mathematics and Mechanics</li><li>• Students will be expected to show their understanding through questions in context such as calculating the direct tensile stress on a cable</li><li>• Question types may include:<ul style="list-style-type: none"><li>○ Forced choice/controlled response questions, including multiple choice questions</li><li>○ Short answer, closed response questions</li><li>○ Short answer, calculation questions</li><li>○ Extended calculation questions</li></ul></li></ul>
<b>Section B</b>	<ul style="list-style-type: none"><li>• All questions are compulsory</li><li>• Questions in this section will be based on Mathematics and Electrical/Electronics</li><li>• Students will be expected to show their understanding through questions in context such as calculating the voltage gain in a circuit</li><li>• Question types may include:<ul style="list-style-type: none"><li>○ Forced choice/controlled response questions, including multiple choice questions</li><li>○ Short answer, closed response questions</li><li>○ Short answer, calculation questions</li><li>○ Extended calculation questions</li></ul></li></ul>

This will be conducted under examination conditions. For more details refer to the **Administration area**.

A range of question types will be used in the exam.

The **Guide to our Sample Assessment Material** gives more information about the layout and expectations of the exam.

The exam for this unit assesses the following Performance Objectives:

- PO1 – Show knowledge and understanding
- PO2 – Apply knowledge and understanding
- PO3 – Analyse and evaluate knowledge, understanding and performance.

## Synoptic assessment

This unit allows students to gain underpinning knowledge and understanding relevant to the qualification and sector. The NEA units draw on and strengthen this learning with students applying their learning in an applied and practical way.

The following NEA units have synoptic links with this unit. The synoptic grids at the end of these NEA units show these synoptic links.

- F132: Engineering in practice
- F133: Computer Aided Design (CAD)
- F134: Programmable electronics
- F136: Computer Aided Manufacture (CAM)
- F137: Electrical devices and circuits
- F138: Mathematics for engineering

More information about synoptic assessment in these qualifications can be found in **Section 5.2 Synoptic Assessment**.

DRAFT

## 4.2.2 Unit F131: Materials science and technology

### Unit aim

Every manufactured product is made from one or more materials. These materials are carefully selected to meet a variety of needs, such as the properties needed by the part, the appearance desired by the user, and the ability to be manufactured into the required shape, whilst also considering sustainable engineering practices.

In this unit you will learn what is represented by different material properties, the types of material and their relative properties, and how these properties can be affected by different processing techniques. You will also learn about how materials fail in-service.

<b>Unit F131: Materials science and technology</b>	
<b>Topic Area 1: Material properties</b>	
<b>Teaching content</b>	<b>Breadth and depth</b>
<b>1.1 Mechanical properties</b>	
<ul style="list-style-type: none"> <li>□ Properties               <ul style="list-style-type: none"> <li>• Strength                   <ul style="list-style-type: none"> <li>○ Torsional</li> <li>○ Fatigue</li> <li>○ Tensile</li> <li>○ Compressive</li> <li>○ Shear</li> </ul> </li> <li>• Ductility</li> <li>• Malleability</li> <li>• Machineability</li> <li>• Toughness</li> <li>• Rigidity/stiffness</li> <li>• Hardness</li> <li>• Creep resistance</li> </ul> </li> <li>□ Characteristic features of the load-extension graph when tensile testing:               <ul style="list-style-type: none"> <li>• Ferrous metals</li> <li>• Non-ferrous metals</li> <li>• Thermoplastic polymers</li> <li>• Ceramics</li> <li>• Composites</li> </ul> </li> <li>□ Material testing methods:               <ul style="list-style-type: none"> <li>• Tensile strength</li> <li>• Toughness (Izod and Charpy)</li> <li>• Fatigue strength (Wohler test)</li> </ul> </li> </ul>	<p>To include:</p> <ul style="list-style-type: none"> <li>□ Definitions and meanings of the properties</li> <li>□ Appropriate units of measure</li> <li>□ Descriptions of test methods</li> <li>□ Characteristic features of the load-extension graph:               <ul style="list-style-type: none"> <li>• Yield strength</li> <li>• Ultimate tensile strength</li> <li>• Limit of plasticity</li> <li>• Maximum elongation</li> <li>• Fracture</li> <li>• Necking</li> <li>• Elastic region</li> <li>• Plastic region</li> </ul> </li> </ul> <p>Does not include:</p> <ul style="list-style-type: none"> <li>□ Drawing of graphs</li> <li>□ The need for calculations</li> </ul>
<b>1.2 Physical properties</b>	
<ul style="list-style-type: none"> <li>□ Density</li> <li>□ Melting point</li> <li>□ Corrosion resistance</li> <li>□ Electrical conductivity/resistivity</li> <li>□ Hardenability</li> <li>□ Thermal conductivity</li> <li>□ Thermal expansivity</li> <li>□ Fusibility</li> <li>□ Weldability</li> </ul>	<p>To include:</p> <ul style="list-style-type: none"> <li>□ Definitions and meanings of the properties</li> <li>□ Difference between mechanical properties and physical properties</li> </ul>

Topic Area 2: Types of material	
Teaching content	Breadth and depth
<b>2.1 Metals</b>	
<b>2.1.1 Ferrous metals (containing iron)</b> <ul style="list-style-type: none"> <li><input type="checkbox"/> Cast iron</li> <li><input type="checkbox"/> Low carbon steel</li> <li><input type="checkbox"/> Medium carbon steel</li> <li><input type="checkbox"/> High carbon steel</li> <li><input type="checkbox"/> Stainless steel</li> </ul>	To include: <ul style="list-style-type: none"> <li><input type="checkbox"/> Difference between pure metals and alloys</li> <li><input type="checkbox"/> Relative properties of the ferrous metals to each other and alternative materials</li> <li><input type="checkbox"/> The relationship between the crystalline structure, lattice structure and the material properties</li> <li><input type="checkbox"/> Bonding mechanism (metallic)</li> <li><input type="checkbox"/> Typical applications and why the general properties of the material make it suitable for these applications and why the material is appropriate for the application</li> <li><input type="checkbox"/> Standard forms of supply:               <ul style="list-style-type: none"> <li>• Ingot/billet</li> <li>• Sheet</li> <li>• Bar</li> <li>• Flat stock</li> <li>• Castings</li> </ul> </li> </ul>
<b>2.1.2 Non-ferrous metals (containing no iron)</b> <ul style="list-style-type: none"> <li><input type="checkbox"/> Aluminium and its alloys</li> <li><input type="checkbox"/> Titanium</li> <li><input type="checkbox"/> Copper</li> <li><input type="checkbox"/> Nickel</li> <li><input type="checkbox"/> Zinc</li> <li><input type="checkbox"/> Brass</li> <li>Lithium</li> </ul>	To include: <ul style="list-style-type: none"> <li><input type="checkbox"/> Difference between ferrous and non-ferrous metals</li> <li><input type="checkbox"/> Relative properties of the non-ferrous metals to each other and alternative materials</li> <li><input type="checkbox"/> The relationship between the crystalline structure, lattice structure and the material properties</li> <li><input type="checkbox"/> Bonding mechanism (metallic)</li> <li><input type="checkbox"/> Typical applications and why the general properties of the material make it suitable for these applications</li> <li><input type="checkbox"/> Standard forms of supply:               <ul style="list-style-type: none"> <li>• Ingot/billet</li> <li>• Sheet</li> <li>• Bar/rod</li> <li>• Flat stock</li> <li>• Castings</li> </ul> </li> </ul>



<b>2.2 Polymers</b>	
<b>2.2.1 Thermoplastic polymers</b> <ul style="list-style-type: none"> <li><input type="checkbox"/> Acrylonitrile-Butadiene-Styrene (ABS)</li> <li><input type="checkbox"/> High impact polystyrene (HIPS)</li> <li><input type="checkbox"/> Polypropylene (PP)</li> <li><input type="checkbox"/> Polycarbonate</li> <li><input type="checkbox"/> Polylactic acid (PLA)</li> </ul>	<b>To include:</b> <ul style="list-style-type: none"> <li><input type="checkbox"/> Composition and structure (repeating monomers)</li> <li><input type="checkbox"/> Bonding mechanisms: <ul style="list-style-type: none"> <li>• Covalent</li> <li>• Van der Waals forces</li> </ul> </li> <li><input type="checkbox"/> Relative properties of the thermoplastic polymers compared to other polymer types and alternative materials</li> <li><input type="checkbox"/> Typical applications and why the general properties of the material make it suitable for these applications</li> <li><input type="checkbox"/> Standard forms of supply: <ul style="list-style-type: none"> <li>• Sheet</li> <li>• Bar/rod</li> <li>• Granules</li> <li>• Liquids</li> </ul> </li> </ul>
<b>2.2.2 Thermosetting polymers</b> <ul style="list-style-type: none"> <li><input type="checkbox"/> Urea formaldehyde</li> <li><input type="checkbox"/> Melamine formaldehyde</li> <li><input type="checkbox"/> Phenol formaldehyde</li> <li><input type="checkbox"/> Epoxy resin</li> <li><input type="checkbox"/> Polyester resin</li> </ul>	<b>To include:</b> <ul style="list-style-type: none"> <li><input type="checkbox"/> Difference between thermoplastic and thermosetting polymers</li> <li><input type="checkbox"/> Influence of cross-linking on material properties</li> <li><input type="checkbox"/> Composition and structure (repeating monomers)</li> <li><input type="checkbox"/> Relative properties of the thermoplastic polymers compared to other polymer types and alternative materials</li> <li><input type="checkbox"/> Typical applications and why the general properties of the material make it suitable for these applications</li> </ul>
<b>2.3 Engineering ceramics</b>	
<ul style="list-style-type: none"> <li><input type="checkbox"/> Silicon carbide</li> <li><input type="checkbox"/> Tungsten carbide</li> <li><input type="checkbox"/> (Silicate) glass</li> </ul>	<b>To include:</b> <ul style="list-style-type: none"> <li><input type="checkbox"/> Relative properties compared to alternative materials</li> <li><input type="checkbox"/> Bonding mechanisms (ionic and covalent)</li> <li><input type="checkbox"/> Typical applications and why the general properties of the material make it suitable for these applications</li> <li><input type="checkbox"/> Standard forms of supply: <ul style="list-style-type: none"> <li>• Powder</li> </ul> </li> </ul>
<b>2.4 Composite materials</b>	
<ul style="list-style-type: none"> <li><input type="checkbox"/> Glass reinforced polymer (GRP/fibreglass)</li> <li><input type="checkbox"/> Carbon reinforced polymer (CRP)</li> </ul>	<b>To include:</b> <ul style="list-style-type: none"> <li><input type="checkbox"/> Difference between metal alloys and composite materials</li> <li><input type="checkbox"/> Relative properties compared to alternative materials</li> <li><input type="checkbox"/> Influence of matrix/reinforcement ratio on tensile strength</li> <li><input type="checkbox"/> Typical applications and why the general properties of the material make it suitable for these applications</li> </ul>

<b>2.5 Modern materials</b>	
<ul style="list-style-type: none"> <li><input type="checkbox"/> Graphene</li> <li><input type="checkbox"/> Metal foams</li> <li><input type="checkbox"/> Nanomaterials</li> </ul>	<p>To include:</p> <ul style="list-style-type: none"> <li><input type="checkbox"/> Unique properties of the stated materials</li> <li><input type="checkbox"/> Typical applications and why the general properties of the material make it suitable for these applications</li> </ul>
<b>2.6 Semiconductor materials</b>	
<ul style="list-style-type: none"> <li><input type="checkbox"/> Silicon</li> <li><input type="checkbox"/> Gallium arsenide</li> <li><input type="checkbox"/> Germanium</li> <li><input type="checkbox"/> Indium</li> <li><input type="checkbox"/> Antimony</li> </ul>	<p>To include:</p> <ul style="list-style-type: none"> <li><input type="checkbox"/> The mechanism by which semiconductors conduct electricity at a sub-atomic level.</li> <li><input type="checkbox"/> What is meant by doping, 'npn' and 'pnp' junctions.</li> <li><input type="checkbox"/> Space charge or depletion region creation</li> <li><input type="checkbox"/> Typical applications of these materials</li> </ul>
<b>2.7 Smart materials</b>	
<ul style="list-style-type: none"> <li><input type="checkbox"/> Shape memory alloy (SMA)</li> <li><input type="checkbox"/> Thermochromic pigment</li> <li><input type="checkbox"/> Photochromic pigment</li> <li><input type="checkbox"/> Piezoelectric crystals</li> <li><input type="checkbox"/> Quantum tunnelling composite (QTC)</li> </ul>	<p>To include:</p> <ul style="list-style-type: none"> <li><input type="checkbox"/> Definition of a smart material</li> <li><input type="checkbox"/> Smart properties of the stated materials</li> <li><input type="checkbox"/> Typical applications and why the general properties of the material make it suitable for these applications</li> <li><input type="checkbox"/> Standard forms of supply</li> </ul>
<b>Topic Area 3: Effect of processing techniques on material properties</b>	
<b>Teaching content</b>	<b>Breadth and depth</b>
<b>3.1 Processing techniques and heat treatment</b>	
<b>3.1.1 Processing techniques</b>	<b>To include:</b>
<ul style="list-style-type: none"> <li><input type="checkbox"/> Metals: <ul style="list-style-type: none"> <li>• Forming <ul style="list-style-type: none"> <li>○ Rolling</li> <li>○ Forging</li> <li>○ Moulding/press forming</li> </ul> </li> <li>• Welding</li> <li>• Casting</li> <li>• Hot working</li> <li>• Cold working</li> <li>• Turning</li> </ul> </li> <li><input type="checkbox"/> Thermoplastic polymers: <ul style="list-style-type: none"> <li>• Injection moulding/pressure moulding</li> </ul> </li> <li><input type="checkbox"/> Thermosetting polymers: <ul style="list-style-type: none"> <li>• Curing</li> </ul> </li> <li><input type="checkbox"/> Ceramics: <ul style="list-style-type: none"> <li>• Sintering</li> <li>• Firing</li> </ul> </li> <li><input type="checkbox"/> Composites: <ul style="list-style-type: none"> <li>• Lay-up</li> </ul> </li> </ul>	<ul style="list-style-type: none"> <li><input type="checkbox"/> For all processes: <ul style="list-style-type: none"> <li>• Stages of the processing techniques</li> <li>• Influence on structure of the material and its properties</li> </ul> </li> <li><input type="checkbox"/> Composites: <ul style="list-style-type: none"> <li>• Effect of alignment of reinforcement on anisotropy of properties</li> </ul> </li> <li><input type="checkbox"/> Pressures, forces and temperatures where used in processing techniques</li> </ul>

<p><b>3.1.2 Heat treatment</b></p> <ul style="list-style-type: none"> <li>□ Ferrous metals: <ul style="list-style-type: none"> <li>• Case hardening</li> <li>• Quench hardening</li> <li>• Tempering</li> <li>• Normalising</li> </ul> </li> <li>□ Aluminium alloys: <ul style="list-style-type: none"> <li>• Annealing</li> <li>• Precipitation hardening</li> </ul> </li> </ul>	<p>To include:</p> <ul style="list-style-type: none"> <li>□ Influence on structure of the material and properties</li> </ul>
<b>Topic Area 4: Material failure mechanisms and prevention</b>	
<b>Teaching content</b>	<b>Breadth and depth</b>
<ul style="list-style-type: none"> <li>□ Failure mechanisms <ul style="list-style-type: none"> <li>• Overstressing</li> <li>• Brittle fracture</li> <li>• Fatigue</li> <li>• Creep</li> <li>• Erosion</li> <li>• Thermal expansion</li> <li>• Thermal cycling</li> <li>• Corrosion</li> <li>• Pitting</li> <li>• Stress corrosion cracking</li> </ul> </li> <li>□ Types of corrosion prevention process: <ul style="list-style-type: none"> <li>• Coatings <ul style="list-style-type: none"> <li>○ Paint</li> <li>○ Polymer/powder</li> <li>○ Electroplating</li> </ul> </li> <li>• Galvanising</li> <li>• Cathodic protection</li> </ul> </li> <li>□ Methods to prevent common failure mechanisms from occurring: <ul style="list-style-type: none"> <li>• Component geometry – consistent cross-sections of material and where possible the removal of keyways, holes or inset corners</li> <li>• Reduction of operating temperature/pressure</li> <li>• Material processing – surface hardening, smoother surface finishing by polishing</li> </ul> </li> </ul>	<p>To include:</p> <ul style="list-style-type: none"> <li>□ How each mechanism results in failure</li> <li>□ The factors that contribute to fatigue failure (cyclic loading, below yield strength, stress raisers)</li> <li>□ The three stages of creep</li> <li>□ The benefits and limitations of the different types of corrosion prevention process in typical applications</li> </ul> <p>Does not include:</p> <ul style="list-style-type: none"> <li>□ Detailed step-by-step knowledge of setting-up and completing the corrosion prevention processes</li> </ul>

<b>Topic Area 5: Sustainable materials and practices in engineering</b>	
<b>Teaching content</b>	<b>Breadth and depth</b>
<ul style="list-style-type: none"> <li>□ The consequences of not adopting sustainable engineering practices</li> <li>□ Concept of the circular economy</li> <li>□ How finite resources are used during the production of virgin materials and the impact that their use has on the environment:               <ul style="list-style-type: none"> <li>• Oil used to make polymers</li> <li>• Energy sources to process metals and ceramics</li> </ul> </li> <li>□ Designing for efficient use of resources, 6Rs:               <ul style="list-style-type: none"> <li>• Rethink</li> <li>• Refuse</li> <li>• Reduce</li> <li>• Recycle</li> <li>• Reuse</li> <li>• Repair</li> </ul> </li> <li>□ Methods of identifying and sorting materials for recycling:               <ul style="list-style-type: none"> <li>• Identification markings on plastics</li> <li>• Magnetic systems for metals</li> </ul> </li> <li>□ The use of recycled material in engineering:               <ul style="list-style-type: none"> <li>• Products that can be made with recycled materials</li> <li>• Products that must be made with virgin material</li> </ul> </li> </ul>	<p>To include:</p> <ul style="list-style-type: none"> <li>□ The impacts of non-sustainable production</li> <li>□ Understanding the finite resources currently being used in manufacturing</li> <li>□ The circular economy as a concept and how it is implemented</li> <li>□ Design for manufacture to improve efficiency and sustainability of resources</li> <li>□ The application of the 6Rs in engineering settings</li> <li>□ The use of sustainable materials when creating products for long term sustainability and reuse</li> </ul>

## Assessment guidance

This unit is assessed by an exam. The exam is 1 hour and 15 minutes. It has two Sections – Section A and Section B.

- Section A has 20 marks.
- Section B has 30 marks.
- The exam has 50 marks in total.

<b>Section A</b>	<ul style="list-style-type: none"><li>• All questions are compulsory</li><li>• Question types may include:<ul style="list-style-type: none"><li>○ Forced choice/controlled response questions, including ten multiple choice questions</li><li>○ Short answer, closed response questions</li></ul></li></ul>
<b>Section B</b>	<ul style="list-style-type: none"><li>• There will be three compulsory structured questions in this section, which may be structured into part questions</li><li>• Question types may include:<ul style="list-style-type: none"><li>○ Forced choice/controlled response questions</li><li>○ Short answer, closed response questions (with or without diagrams)</li><li>○ Extended constructed response with a points-based mark scheme</li><li>○ One extended constructed response with a levels of response mark scheme</li></ul></li></ul>

This will be conducted under examination conditions. For more details refer to the **Administration area**.

A range of question types will be used in the exam.

The **Guide to our Sample Assessment Material** gives more information about the layout and expectations of the exam.

The exam for this unit assesses the following Performance Objectives:

- PO1 – Show knowledge and understanding
- PO2 – Apply knowledge and understanding
- PO3 – Analyse and evaluate knowledge, understanding and performance.

## Synoptic assessment

This unit allows students to gain underpinning knowledge and understanding relevant to the qualification and sector. The NEA units draw on and strengthen this learning as students will apply their learning to practical and/or applied tasks.

The following NEA units have synoptic links with this unit. The synoptic grids at the end of these NEA units show these synoptic links.

- F132: Engineering in practice
- F133: Computer Aided Design (CAD)
- F135: Mechanical product design
- F136: Computer Aided Manufacture (CAM)

More information about synoptic assessment in these qualifications can be found in **Section 5.2 Synoptic Assessment**.

### 4.2.3 Unit F138: Mathematics for engineering

#### Unit aim

Mathematics underpins many aspects of engineering and is one of the fundamental tools of the engineer. The application of mathematical concepts is common when solving engineering problems.

In this unit you will learn about a range of mathematical concepts including the principles of differential and integral calculus, which are used in many engineering applications. For example, to optimise the fencing around a packaging machine, to control the movement of a two wheeled robot and in kinematics. You will also learn about matrices, statistics and probability, as well as indices, exponentials and logarithms. For example, matrices are used by engineers to model the wireless signals, in computer games to manipulate graphics and to analyse electronic circuits.

Unit F138: Mathematics for engineering	
Topic Area 1: Matrices and determinants	
Teaching content	Breadth and depth
<b>1.1 Matrix notation</b>	
<ul style="list-style-type: none"> <li><input type="checkbox"/> Column</li> <li><input type="checkbox"/> Row</li> <li><input type="checkbox"/> Rectangular</li> <li><input type="checkbox"/> Square</li> </ul>	<p>To include:</p> <ul style="list-style-type: none"> <li><input type="checkbox"/> What is meant by a rectangular matrix</li> <li><input type="checkbox"/> In a matrix the element in the <math>i</math>th row and <math>j</math>th column is <math>a_{ij}</math>.</li> <li><input type="checkbox"/> Square matrices</li> <li><input type="checkbox"/> The identity matrix <math>I = \begin{vmatrix} 1 &amp; 0 \\ 0 &amp; 1 \end{vmatrix}</math></li> <li><input type="checkbox"/> Input matrices no higher than <math>3 \times 2</math> and <math>2 \times 3</math></li> </ul> <p>Does not include:</p> <ul style="list-style-type: none"> <li><input type="checkbox"/> Input matrices of <math>3 \times 3</math> or higher</li> </ul>
<b>1.2 Binary operations on matrices</b>	
<ul style="list-style-type: none"> <li><input type="checkbox"/> Rules of operation</li> <li><input type="checkbox"/> Addition and subtraction can only be carried out on matrices of the same size</li> <li><input type="checkbox"/> Multiplication can only be carried out on two matrices that are “compatible”</li> <li><input type="checkbox"/> Matrix multiplication is not, in general, commutative</li> </ul>	<p>To include:</p> <ul style="list-style-type: none"> <li><input type="checkbox"/> Matrix addition and subtraction and multiplication by a number</li> <li><input type="checkbox"/> In matrix multiplication <ul style="list-style-type: none"> <li><input type="checkbox"/> <math>(m \times n) \times (n \times p)</math> gives a matrix of size <math>(m \times p)</math></li> <li><input type="checkbox"/> In matrix multiplication <math>AB \neq BA</math></li> </ul> </li> <li><input type="checkbox"/> Input matrices no higher than <math>3 \times 2</math> and <math>2 \times 3</math></li> </ul> <p>Does not include:</p> <ul style="list-style-type: none"> <li><input type="checkbox"/> The associative law</li> <li><input type="checkbox"/> Input matrices of <math>3 \times 3</math> or higher</li> </ul>

<b>1.3 Determinants</b>	
<ul style="list-style-type: none"> <li>□ Calculation of the determinant of a <math>2 \times 2</math> matrix</li> </ul>	<p>To include:</p> <ul style="list-style-type: none"> <li>□ For a <math>2 \times 2</math> matrix <math>M = \begin{vmatrix} a &amp; b \\ c &amp; d \end{vmatrix}, \text{Det}M = ad - cb</math></li> <li>□ A matrix M is singular if <math>\text{Det}M = 0</math></li> </ul> <p>Does not include:</p> <ul style="list-style-type: none"> <li>□ Calculation of the determinant of <math>3 \times 3</math> matrices or higher</li> </ul>
<b>1.4 Inverses</b>	
<ul style="list-style-type: none"> <li>□ Calculation of the inverse of a matrix</li> </ul>	<p>To include:</p> <ul style="list-style-type: none"> <li>□ For a <math>2 \times 2</math> matrix <math>M = \begin{vmatrix} a &amp; b \\ c &amp; d \end{vmatrix}, M^{-1} = \frac{1}{\text{Det}M} \begin{vmatrix} d &amp; -b \\ -c &amp; a \end{vmatrix}</math></li> <li>□ <math>M.M^{-1} = M^{-1}.M = I</math></li> </ul> <p>Does not include:</p> <ul style="list-style-type: none"> <li>□ Calculation of <math>3 \times 3</math> matrices or higher</li> </ul>
<b>1.5 Solution of two simultaneous linear equations</b>	
<ul style="list-style-type: none"> <li>□ Application of matrix theory to solve two linear equations in two unknowns</li> </ul>	<p>To include:</p> <ul style="list-style-type: none"> <li>□ Represent linear simultaneous equations with 2 unknowns in matrix notation</li> <li>□ Use of the inverse of the matrix of coefficients to solve the equations</li> <li>□ The significance of a singular matrix of coefficients</li> </ul> <p>Does not include:</p> <ul style="list-style-type: none"> <li>□ 3 linear equations in 3 unknowns and higher</li> </ul>
<b>Topic Area 2: Differential calculus</b>	
<b>Teaching content</b>	<b>Breadth and depth</b>
<b>2.1 Graphical representation of functions</b>	
<ul style="list-style-type: none"> <li>□ Sketching graphs of functions</li> <li>□ Finding the gradient of a function graphically</li> <li>□ Instantaneous gradient at a point on a curve</li> <li>□ Positive, negative and zero values for gradients</li> </ul>	<p>To include:</p> <ul style="list-style-type: none"> <li>□ Polynomial functions of the form <math>y = ax^3 + bx^2 + cx + d</math> where <math>a, b, c, d</math> are positive or negative constants</li> <li>□ Algebraic functions to include <math>ax^n</math> where <math>n</math> is positive or negative power, including fractional</li> <li>□ Trigonometrical functions of the form: <math>y = a \cos x</math> and <math>y = a \cos bx + c \sin cx</math> where <math>a, b, c, d</math> are positive or negative constants</li> <li>□ Exponential functions of the form <math>y = ae^{bx}</math></li> </ul> <p>Does not include:</p> <ul style="list-style-type: none"> <li>□ Plotting graph</li> </ul>

## 2.2 Differential calculus

- Differentiation of
  - Polynomial functions
  - Exponential functions
  - Trigonometrical functions
  - Function of a function
  - Products
- Substitution of a value for  $x$  to find the gradient of the curve

To include:

- The notation  $\frac{dy}{dx}$  means the rate of change of  $y$  with respect to  $x$
- The use of the term “gradient function” to mean the derivative of a function
- The gradient function of a sum of terms is the sum of gradient functions
- Standard derivatives:

$$y = a \Rightarrow \frac{dy}{dx} = 0$$

$$y = ax^n \Rightarrow \frac{dy}{dx} = anx^{n-1} \text{ for all } n$$

$$y = a \cos bx + c \sin dx \Rightarrow \frac{dy}{dx} = -ab \sin bx + cd \cos dx$$

$$y = ae^{bx} \Rightarrow \frac{dy}{dx} = abe^{bx}$$

- Functions of a function /chain rule:  
 $y = f(z)$  where  $z = g(x)$  then  $\frac{dy}{dx} = \frac{dy}{dz} \cdot \frac{dz}{dx}$

In the form of  $\sin ax$  and  $\sqrt{(1 + x^4)}$

- Products  
 $y = uv$  where  $u$  and  $v$  are functions of  $x$   
 $\frac{dy}{dx} = u \frac{dv}{dx} + v \frac{du}{dx}$

- Use of the SUVAT formulae for constant acceleration:

- $v = u + at$
- $v^2 = u^2 + 2as$
- $s = ut + \frac{1}{2}at^2$
- $s = \frac{1}{2}(u + v)t$

Where:  $s$  is distance,  $u$  is initial velocity,  $v$  is final velocity,  $a$  is acceleration and  $t$  is time

- Application of differentiation in kinematics:  
Velocity = rate of change of

$$\text{displacement: } v = \frac{ds}{dt}$$

Acceleration = rate of change of velocity:

$$a = \frac{dv}{dt} = \frac{d^2s}{dt^2}$$



	<ul style="list-style-type: none"> <li>□ Other applications of differential calculus involve oscillation, area/volume, force, capacitor, inductor and electronic signals</li> <li>□ Substitution of numerical values into the expression for the derivative to determine the gradient</li> </ul> <p>Does not include:</p> <ul style="list-style-type: none"> <li>□ Functions of functions in the form of: <ul style="list-style-type: none"> <li>• <math>y = e^{x^2}</math> or <math>e^{\sin x}</math></li> </ul> </li> <li>□ Quotients</li> <li>□ Logs</li> </ul>
--	--

<b>2.3 Stationary values</b>	
<ul style="list-style-type: none"> <li>□ A maximum or minimum value of a function is where the gradient of the graph is zero</li> <li>□ The determination of whether a stationary value is a maximum or minimum by: <ul style="list-style-type: none"> <li>• Calculation of values of the function either side of the stationary value</li> <li>• Calculation of the gradient either side of the stationary value</li> <li>• Differentiating twice, using the notation <math>\frac{d^2y}{dx^2}</math></li> </ul> </li> </ul>	<p>To include:</p> <ul style="list-style-type: none"> <li>□ If the value of the function is greater than that at the stationary value on both sides of the stationary value then it is a minimum value and vice versa</li> <li>□ If the value of the gradient is positive to the left of the stationary value and negative to the right then it is a maximum and vice versa</li> <li>□ If <math>\frac{d^2y}{dx^2} &gt; 0</math> at the stationary value then <math>\frac{dy}{dx}</math> is an increasing function and so is negative to the left of the stationary value, 0 at the stationary value and positive to the right meaning that it is a minimum value, and vice versa</li> </ul> <p>Does not include:</p> <ul style="list-style-type: none"> <li>□ Limiting processes</li> </ul>

Topic Area 3: Integral calculus	
Teaching content	Breadth and depth
<b>3.1. Integration of functions</b>	
<ul style="list-style-type: none"> <li>□ Integration is the reverse of differentiation</li> <li>□ Standard notation for integration: <math>I = \int f(x)dx</math></li> <li>□ A sum of terms is integrated term by term</li> <li>□ Indefinite integration includes an arbitrary constant of integration, <math>C</math></li> <li>□ Standard integrals:  <math>\int a dx = ax</math>  <math>\int ax^n dx = a \frac{x^{n+1}}{n+1} + C</math> for all values of <math>n \neq -1</math>  <math>\int (a \cos bx + c \sin dx)dx = a \frac{\sin bx}{b} - c \frac{\cos dx}{d} + C</math>  <math>\int ae^{bx} dx = \frac{a}{b} e^{bx} + C</math></li> <li>□ Use of integral calculus with kinematic applications</li> </ul>	<p>To include:</p> <ul style="list-style-type: none"> <li>□ Integration of <ul style="list-style-type: none"> <li>• Polynomial functions</li> <li>• Exponential functions</li> <li>• Trigonometrical functions</li> </ul> </li> <li>□ Application of kinematics: <math>v = \int a(t)dt, s = \int v(t)dt</math></li> <li>□ Other applications of integral calculus could involve work done, mass, area/volume, capacitors, inductors and electrical power</li> </ul> <p>Does not include:</p> <ul style="list-style-type: none"> <li>□ Integration by parts, substitution methods</li> <li>□ Logs</li> </ul>
<b>3.2 Definite and indefinite integrals</b>	
<ul style="list-style-type: none"> <li>□ The area under a curve</li> <li>□ Definite integrals have upper and lower limits, where:  <math>\int_a^b f(x) dx = [F(x)]_a^b = F(b) - F(a)</math></li> <li>□ The area between two curves</li> </ul>	<p>To include:</p> <ul style="list-style-type: none"> <li>□ Area is always positive, but area under the axis, when calculated by integration, will be negative</li> </ul> <p>Does not include:</p> <ul style="list-style-type: none"> <li>□ Calculation of area when the curve crosses the axis between the two limits</li> </ul>
<b>3.3 Numerical methods to find the area under a curve whose function cannot be integrated</b>	
<ul style="list-style-type: none"> <li>□ Use of rectangular strips</li> <li>□ The trapezium rule:  <math>\int_a^b f(x) dx \approx \frac{h}{2} [f(x_0) + f(x_n) + 2 \times (f(x_1) + f(x_2) + \dots + f(x_{n-1}))]</math></li> <li>□ Where <math>h = \frac{b-a}{n}</math>, and <math>n</math> is the number of subintervals</li> <li>□ Simpson's rule:  <math>\int_a^b f(x) dx \approx \frac{h}{3} [f(x_0) + f(x_n) + 4 \times (f(x_1) + f(x_3) + \dots) + 2 \times (f(x_2) + f(x_4) + \dots)]</math></li> <li>□ Where <math>h = \frac{b-a}{n}</math>, and <math>n</math> is the number of subintervals</li> </ul>	<p>To include:</p> <ul style="list-style-type: none"> <li>□ Use these methods to find an approximate value for an area</li> <li>□ Understanding of whether the result is an overestimate or underestimate</li> <li>□ Understanding that the trapezium rule is more accurate and that Simpson's rule is even more accurate</li> <li>□ Engineering applications using kinematics and other applications in mechanics and electrical/electronics</li> </ul> <p>Does not include: Derivation of these rules</p>

<b>Topic Area 4: Statistics and probability</b>	
<b>Teaching content</b>	<b>Breadth and depth</b>
<b>4.1 Sampling</b>	
<ul style="list-style-type: none"> <li><input type="checkbox"/> Population</li> <li><input type="checkbox"/> Sample</li> <li><input type="checkbox"/> Random and non-random sampling</li> </ul>	<p>To include:</p> <ul style="list-style-type: none"> <li><input type="checkbox"/> Know the reasons for using a sample</li> <li><input type="checkbox"/> Know the reasons for using random and non-random sampling</li> </ul> <p>Does not include:</p> <ul style="list-style-type: none"> <li><input type="checkbox"/> Specific sampling techniques</li> </ul>
<b>4.2 Single variable data and data handling</b>	
<ul style="list-style-type: none"> <li><input type="checkbox"/> Categorical</li> <li><input type="checkbox"/> Discrete</li> <li><input type="checkbox"/> Continuous</li> </ul>	<p>To include:</p> <ul style="list-style-type: none"> <li><input type="checkbox"/> Know the difference between categorical, discrete, and continuous data</li> <li><input type="checkbox"/> Grouping continuous data</li> </ul> <p>Does not include:</p> <ul style="list-style-type: none"> <li><input type="checkbox"/> Large data sets</li> </ul>
<b>4.3 Grouped data</b>	
<ul style="list-style-type: none"> <li><input type="checkbox"/> Working with grouped and ungrouped data</li> <li><input type="checkbox"/> Grouping ungrouped data into appropriate groups</li> </ul>	<p>To include:</p> <ul style="list-style-type: none"> <li><input type="checkbox"/> The use of equal and unequal group sizes in a data set when appropriate</li> </ul>
<b>4.4 Statistical diagrams</b>	
<ul style="list-style-type: none"> <li><input type="checkbox"/> Charts <ul style="list-style-type: none"> <li>• Bar charts</li> <li>• Histograms</li> <li>• Vertical line chart</li> </ul> </li> <li><input type="checkbox"/> Cumulative frequency curves</li> <li><input type="checkbox"/> Pie charts</li> <li><input type="checkbox"/> Stem and leaf diagram</li> <li><input type="checkbox"/> Box and whisker diagram</li> </ul>	<p>To include:</p> <ul style="list-style-type: none"> <li><input type="checkbox"/> Know when to use a particular diagram</li> <li><input type="checkbox"/> Know the difference between a bar chart and a histogram</li> <li><input type="checkbox"/> Constructing and extracting data from a histogram with unequal group widths</li> <li><input type="checkbox"/> Be able to extract data from a given chart</li> </ul>
<b>4.5 Measures of central tendency</b>	
<ul style="list-style-type: none"> <li><input type="checkbox"/> Mean, median, mode for grouped and ungrouped data</li> </ul>	<p>To include:</p> <ul style="list-style-type: none"> <li><input type="checkbox"/> Calculation and interpretation of these measures from given data or extracted from given diagrams for grouped continuous data and for discrete data</li> </ul> <p>Does not include:</p> <ul style="list-style-type: none"> <li><input type="checkbox"/> Geometric and harmonic means</li> </ul>

<b>4.6 Measures of dispersion</b>	
<ul style="list-style-type: none"> <li><input type="checkbox"/> Percentiles</li> <li><input type="checkbox"/> Range</li> <li><input type="checkbox"/> Interquartile range (IQR)</li> <li><input type="checkbox"/> Variance</li> <li><input type="checkbox"/> Standard deviation</li> </ul>	<p>To include:</p> <ul style="list-style-type: none"> <li><input type="checkbox"/> Calculation of these measures using a calculator</li> <li><input type="checkbox"/> The upper quartile is the 75% percentile</li> <li><input type="checkbox"/> The lower quartile is the 25% percentile</li> <li><input type="checkbox"/> The interquartile range = upper quartile – lower quartile</li> <li><input type="checkbox"/> Extract these values from a cumulative frequency curve</li> </ul> <p>Does not include:</p> <ul style="list-style-type: none"> <li><input type="checkbox"/> Standard error of the mean</li> </ul>
<b>4.7 Outliers</b>	
<ul style="list-style-type: none"> <li><input type="checkbox"/> Identifying outliers</li> </ul>	<p>To include:</p> <ul style="list-style-type: none"> <li><input type="checkbox"/> Know that an outlier is an item which is inconsistent with the rest of the data</li> <li><input type="checkbox"/> Know that an outlier can be: <ul style="list-style-type: none"> <li>• At least 2 Standard deviations from the mean, or</li> <li>• At least 1.5IQR from the nearest quartile</li> </ul> </li> </ul>
<b>4.8 Probability</b>	
<ul style="list-style-type: none"> <li><input type="checkbox"/> The concept of chance</li> <li><input type="checkbox"/> Mutually exclusive and non-mutually exclusive events</li> <li><input type="checkbox"/> Use of Venn diagrams</li> <li><input type="checkbox"/> Dependent and independent events</li> <li><input type="checkbox"/> Use of tree diagrams</li> </ul>	<p>To include:</p> <ul style="list-style-type: none"> <li><input type="checkbox"/> Theoretical and experimental probability</li> <li><input type="checkbox"/> Trials and events</li> <li><input type="checkbox"/> Certainty</li> <li><input type="checkbox"/> Impossibility</li> <li><input type="checkbox"/> The complement of an event: <math>A, A'</math>: <math>A + A' = 1</math></li> <li><input type="checkbox"/> Mutually exclusive events: <math>P(A \cup B) = P(A) + P(B)</math></li> <li><input type="checkbox"/> Non mutually exclusive events: <math>P(A \cup B) = P(A) + P(B) - P(A \cap B)</math></li> <li><input type="checkbox"/> If A and B are independent <math>P(A \text{ and } B) = P(A) \times P(B)</math></li> <li><input type="checkbox"/> If B is dependent on the outcome of A <math>P(A \text{ and } B) = P(A) \times P(B A)</math></li> </ul> <p>Does not include:</p> <ul style="list-style-type: none"> <li><input type="checkbox"/> Conditional probability</li> </ul>

Topic Area 5: Indices, exponentials and logarithms	
Teaching content	Breadth and depth
<b>5.1 Laws of indices</b>	
<ul style="list-style-type: none"> <li>□ Multiplication <math>a^m \times a^n = a^{(m+n)}</math></li> <li>□ Division <math>\frac{a^m}{a^n} = a^{(m-n)}</math></li> <li>□ Powers of powers <math>(a^m)^n = a^{mn}</math></li> <li>□ Negative powers <math>a^{-m} = \frac{1}{a^m}</math></li> <li>□ Zero power <math>a^0 = 1</math></li> <li>□ Fractional powers <math>a^{\frac{m}{n}} = (\sqrt[n]{a})^m</math></li> </ul>	<p>To include:</p> <ul style="list-style-type: none"> <li>□ Know that roots are expressed as powers in fractional powers</li> </ul>
<b>5.2 Logarithms as inverses of an exponential form</b>	
	<p>To include:</p> <ul style="list-style-type: none"> <li>□ <math>a^y = x \Leftrightarrow y = \log_{a \rightarrow} x</math></li> </ul>
<b>5.3 Laws of logarithms</b>	
<ul style="list-style-type: none"> <li>□ Multiplication <math>\log AB = \log A + \log B</math></li> <li>□ Division <math>\log \frac{A}{B} = \log A - \log B</math></li> <li>□ Powers of powers <math>\log A^n = n \log A</math></li> <li>□ Negative powers <math>\log \left(\frac{1}{x^A}\right) = -A</math></li> <li>□ Zero power <math>\log A^0 = 0</math></li> </ul>	<p>To include:</p> <ul style="list-style-type: none"> <li>□ <math>\log_a a = 1, \log_a 1 = 0</math></li> </ul> <p>Does not include:</p> <ul style="list-style-type: none"> <li>□ Change of base</li> </ul>
<b>5.4 Know and use the exponential function <math>y = a^x</math> and its graph</b>	
	<p>To include:</p> <ul style="list-style-type: none"> <li>□ <math>a &gt; 0</math></li> </ul>
<b>5.5 Solution of equations of the form <math>a^x = b</math></b>	
<b>5.6 Know and use the function <math>y = e^x</math> and its graph</b>	
	<p>To include:</p> <ul style="list-style-type: none"> <li>□ The significance of the exponential number <math>e = 2.718</math></li> <li>□ Solving equations involving exponentials by applying natural logarithms, in the form of: <math display="block">y = e^{ax} \Rightarrow \ln y = ax</math></li> </ul>
<b>5.7 Know the connection between the exponential function and its gradient</b>	
	<p>To include:</p> <ul style="list-style-type: none"> <li>□ <math>\frac{d}{dx}(e^{kx}) = ke^{kx}</math></li> </ul>
<b>5.8 Growth and decay</b>	
<ul style="list-style-type: none"> <li>□ Solve problems involving exponential growth and decay.</li> <li>□ The use of modelling to represent real life situations</li> </ul>	<p>To include:</p> <ul style="list-style-type: none"> <li>□ The limitations of such models</li> </ul>
<b>5.9 Reduction of <math>y = ax^n</math> and <math>y = an^x</math> to linear form</b>	
	<p>To include:</p> <ul style="list-style-type: none"> <li>□ Take logs of both sides to form an equation of the form <math>Y = mX + c</math> and plot in order to estimate parameters</li> </ul>

## Assessment guidance

This unit is assessed by an exam. The exam is 1 hour and 15 minutes. The exam has 55 marks in total. All questions in the exam are compulsory.

<b>F138</b> Question paper	<ul style="list-style-type: none"><li>• Question types may include:<ul style="list-style-type: none"><li>○ Forced choice/controlled response questions</li><li>○ Short answer, closed response questions,</li><li>○ Short answer, calculation questions</li><li>○ Extended calculation questions</li></ul></li></ul>
----------------------------	--

This will be conducted under examination conditions. For more details refer to the **Administration area**.

A range of question types will be used in the exam.

The **Guide to our Sample Assessment Material** gives more information about the layout and expectations of the exam.

The exam for this unit assesses the following Performance Objectives:

- PO1 – Show knowledge and understanding
- PO2 – Apply knowledge and understanding
- PO3 – Analyse and evaluate knowledge, understanding and performance.

## Synoptic assessment

Some of the knowledge, understanding and skills required when completing this unit will draw on the learning developed in unit F130: Principles of engineering.

The following table details where these synoptic links can be found:

<b>Unit F138: Mathematics for engineering</b>		<b>Unit F130: Principles of engineering</b>	
<b>Topic Area</b>		<b>Topic Area</b>	
2	Differential calculus	1	Mathematics
		2	Mechanical principles

More information about synoptic assessment in these qualifications can be found in **Section 5.2 Synoptic Assessment**.

## 4.3 NEA Units

### 4.3.1 Unit F132: Engineering in practice

#### Essential resources required for this unit:

- CAD software

#### Unit Aim

During the development of new products, engineers and designers analyse existing products to see how successful they have been and to identify areas for improvement. Product analysis allows them to understand the materials, processing, electronics, economic, and aesthetic decisions that need to be made before a product can be manufactured. An understanding of these decisions can help engineers prototype their new products and test them with potential users.

In this unit you will learn how to analyse products, produce engineering CAD drawings and make a component and a circuit prototype. Working on a product with several parts, you will focus on one component part and one electronic circuit that contributes to the product. You will also evaluate your manufactured prototypes to see how successful they have been.

Unit F132: Engineering in practice	
Topic Area 1: Product analysis	
Teaching content	Exemplification
<b>1.1. Product analysis of the components</b>	
<ul style="list-style-type: none"> <li>□ Function of different components in products</li> <li>□ Identification of mechanical features through the inspection of:               <ul style="list-style-type: none"> <li>• Standard components</li> <li>• Non-standard components</li> <li>• Materials</li> <li>• Joints and fixings</li> <li>• Finishing</li> </ul> </li> <li>□ Physical measurement of dimensions of the components using tools</li> <li>□ Recording of results of inspection and dimensions</li> </ul>	<p>To include:</p> <ul style="list-style-type: none"> <li>□ The function of each component in a product</li> <li>□ Standard components are bought-in and manufactured in high volumes for many different products and include fasteners and fixings</li> <li>□ Examples of <b>standard components</b> may include:               <ul style="list-style-type: none"> <li>• Split and clevis pins</li> <li>• Nuts</li> <li>• Bolts</li> <li>• Washers</li> <li>• Screws</li> <li>• Circlips</li> <li>• Pop rivets</li> <li>• Springs</li> <li>• Bearings</li> <li>• Seals</li> </ul> </li> <li>□ Non-standard components are manufactured specifically for use in the product being manufactured</li> </ul> <p>Examples of <b>physical measurement of dimensions of the components using tools</b> may include:</p> <ul style="list-style-type: none"> <li>□ Callipers</li> <li>□ Micrometer</li> <li>□ Steel rule</li> <li>□ Vernier</li> </ul>

	<p>Examples of <b>recording of results of inspection and dimensions</b> may include:</p> <ul style="list-style-type: none"> <li><input type="checkbox"/> Annotation</li> <li><input type="checkbox"/> List of components</li> <li><input type="checkbox"/> Photographs</li> <li><input type="checkbox"/> Sketches</li> <li><input type="checkbox"/> Tables</li> </ul>
<p><b>Topic Area 2: Produce Computer Aided Design (CAD) mechanical and electronic engineering drawings</b></p>	
<p><b>Teaching content</b></p>	<p><b>Exemplification</b></p>
<p><b>2.1 Produce a 2D CAD engineering drawing of a mechanical component</b></p>	
<p><b>2.1.1 Engineering drawing standards</b></p> <ul style="list-style-type: none"> <li><input type="checkbox"/> Third angle orthographic projections</li> <li><input type="checkbox"/> Sectional/detailed views</li> <li><input type="checkbox"/> Isometric assembly projection</li> <li><input type="checkbox"/> Metric units of measurement</li> <li><input type="checkbox"/> Scale</li> <li><input type="checkbox"/> Title block</li> <li><input type="checkbox"/> Tolerance</li> <li><input type="checkbox"/> Diameter and radius</li> <li><input type="checkbox"/> Linear measurements/ dimensions</li> <li><input type="checkbox"/> Use of line types</li> <li><input type="checkbox"/> Use of abbreviations</li> </ul>	<p>To include:</p> <ul style="list-style-type: none"> <li><input type="checkbox"/> Awareness and application of standards such as BS 8888</li> <li><input type="checkbox"/> Examples of <b>line types</b> may include: <ul style="list-style-type: none"> <li>• Centre line</li> <li>• Construction line</li> <li>• Dimension</li> <li>• Hidden detail</li> <li>• Leader line</li> <li>• Outlines</li> <li>• Projection</li> <li>• Section line</li> </ul> </li> <li><input type="checkbox"/> Examples of <b>abbreviations</b> may include: <ul style="list-style-type: none"> <li>• Across flats (AF)</li> <li>• Centre line (CL)</li> <li>• Chamfer (CHAM)</li> <li>• Diameter (DIA)</li> <li>• Drawing (DRG)</li> <li>• Material (MAT)</li> <li>• Radius (R)</li> <li>• Square (SQ)</li> </ul> </li> </ul> <p>Does not include:</p> <ul style="list-style-type: none"> <li><input type="checkbox"/> Pitch Circle Diameter (PCD)</li> </ul>
<p><b>2.2. Produce a CAD engineering drawing of an electronic circuit</b></p>	
<p><b>2.2.1 Engineering drawing standards</b></p> <ul style="list-style-type: none"> <li><input type="checkbox"/> Symbols for electronic components</li> <li><input type="checkbox"/> Units of measurement</li> <li><input type="checkbox"/> Title block</li> </ul>	<p>To include:</p> <ul style="list-style-type: none"> <li><input type="checkbox"/> Awareness of IEC/BS 60617</li> <li><input type="checkbox"/> Appropriate application of conventions</li> </ul> <p>Examples of <b>symbols for electronic components</b> may include:</p> <ul style="list-style-type: none"> <li><input type="checkbox"/> Cell/battery</li> <li><input type="checkbox"/> Switch</li> <li><input type="checkbox"/> Resistor</li> <li><input type="checkbox"/> Diode</li> <li><input type="checkbox"/> Capacitor</li> <li><input type="checkbox"/> Transistor</li> <li><input type="checkbox"/> Integrated circuit</li> <li><input type="checkbox"/> Light dependent resistor (LDR)</li> <li><input type="checkbox"/> Light-emitting diode (LED)</li> <li><input type="checkbox"/> Motor</li> </ul>



	<ul style="list-style-type: none"> <li><input type="checkbox"/> Buzzer</li> <li><input type="checkbox"/> Thermistor</li> <li><input type="checkbox"/> Variable resistor/potentiometer</li> </ul>
<b>2.2.2 Electronic circuit diagrams</b> <ul style="list-style-type: none"> <li><input type="checkbox"/> Selection of correct circuit symbols and components and values to achieve the desired circuit</li> <li><input type="checkbox"/> Orientation and placement of: <ul style="list-style-type: none"> <li>• Symbols and components</li> <li>• Connections</li> </ul> </li> </ul>	<p>To include:</p> <ul style="list-style-type: none"> <li><input type="checkbox"/> Interpretation of visual representation of circuits into circuit diagrams</li> <li><input type="checkbox"/> Consideration of power supply requirements and connections</li> <li><input type="checkbox"/> Consideration of external components</li> </ul> <p>Does not include:</p> <ul style="list-style-type: none"> <li><input type="checkbox"/> The electronic design of circuits</li> <li><input type="checkbox"/> Choice of components to use</li> </ul>
<b>2.2.3 Circuit simulation</b> <ul style="list-style-type: none"> <li><input type="checkbox"/> Use of circuit simulation software</li> <li><input type="checkbox"/> Simulation of a circuit to test functionality against given data</li> <li><input type="checkbox"/> Select and use appropriate virtual test equipment</li> </ul>	<p>To include:</p> <ul style="list-style-type: none"> <li><input type="checkbox"/> Virtual test equipment such as <ul style="list-style-type: none"> <li>• Multimeter</li> <li>• Probe</li> <li>• Voltmeter/ammeter</li> </ul> </li> </ul>
<b>Topic Area 3: Plan the safe manufacture of a mechanical prototype and an electronic circuit prototype</b>	
<b>Teaching content</b>	<b>Exemplification</b>
<b>3.1 Plan the safe manufacture of a mechanical prototype</b>	
<ul style="list-style-type: none"> <li><input type="checkbox"/> Bill of materials (BOM) <ul style="list-style-type: none"> <li>• Raw materials</li> <li>• Standard components</li> </ul> </li> <li><input type="checkbox"/> Choice of equipment and tools</li> <li><input type="checkbox"/> Sequence of operations and processes <ul style="list-style-type: none"> <li>• Timings</li> </ul> </li> <li><input type="checkbox"/> A risk assessment that identifies: <ul style="list-style-type: none"> <li>• Hazards</li> <li>• Risks</li> <li>• Control measures</li> </ul> </li> <li><input type="checkbox"/> Sustainability considerations</li> </ul>	<p>To include:</p> <ul style="list-style-type: none"> <li><input type="checkbox"/> Sustainability considerations: <ul style="list-style-type: none"> <li>• Minimising the use of raw materials</li> <li>• Specifying appropriate forms of supply. Examples of forms of supply may include: <ul style="list-style-type: none"> <li>○ Sheet</li> <li>○ Bar stock</li> <li>○ Pipe and tube</li> <li>○ Extrusions</li> <li>○ Granules/powders</li> </ul> </li> </ul> </li> </ul>
<b>3.2 Plan the safe manufacture of an electronic circuit prototype</b>	
<ul style="list-style-type: none"> <li><input type="checkbox"/> Choice of equipment and tools</li> <li><input type="checkbox"/> Sequence of operations and processes <ul style="list-style-type: none"> <li>• Timings</li> </ul> </li> <li><input type="checkbox"/> Risk assessment to identify: <ul style="list-style-type: none"> <li>• Hazards</li> <li>• Risks</li> <li>• Control measures</li> </ul> </li> <li><input type="checkbox"/> Layout <ul style="list-style-type: none"> <li>• Component size, orientation and positioning</li> <li>• Transfer circuit diagram to layout diagram for either a strip board or a printed circuit board substrate</li> </ul> </li> <li><input type="checkbox"/> Sustainability considerations</li> </ul>	<p>To include:</p> <ul style="list-style-type: none"> <li><input type="checkbox"/> Sustainability considerations: <ul style="list-style-type: none"> <li>• Board size</li> <li>• Track lengths</li> <li>• Wire lengths</li> </ul> </li> </ul>

Topic Area 4: Manufacturing processes	
Teaching content	Exemplification
<b>4.1 Manufacture a mechanical prototype</b>	
<ul style="list-style-type: none"> <li>□ Relevant materials <ul style="list-style-type: none"> <li>• Metals</li> <li>• Polymers</li> </ul> </li> <li>□ Hand and machine processes <ul style="list-style-type: none"> <li>• Marking out/measuring</li> <li>• Subtractive</li> <li>• Forming</li> <li>• Finishing</li> <li>• Joining and assembly</li> </ul> </li> <li>□ Equipment</li> <li>□ Tools</li> <li>□ Safe working practices: <ul style="list-style-type: none"> <li>• Correct procedures</li> <li>• Risk assessment</li> <li>• Appropriate PPE</li> </ul> </li> <li>□ Manufacture a prototype using engineering drawings and planning documentation</li> <li>□ Sustainability considerations</li> </ul>	<p>To include:</p> <ul style="list-style-type: none"> <li>□ Selecting, setting up, using and shutting down engineering processes, equipment, and tools to manufacture a component(s) prototype</li> <li>□ Processes, equipment, and tools used must be appropriate to the task/component</li> <li>□ Sustainability considerations may include: <ul style="list-style-type: none"> <li>• Reduction of waste including the use of raw materials and consumables and preventing defects</li> <li>• Minimise energy use</li> <li>• Recycle waste material</li> </ul> </li> </ul> <p><b>Examples of hand and machine processes</b> may include:</p> <ul style="list-style-type: none"> <li>□ Marking out/measuring using: <ul style="list-style-type: none"> <li>• Engineers blue</li> <li>• Pencil</li> <li>• Ruler</li> <li>• Tape measure</li> <li>• Vernier callipers</li> </ul> </li> <li>□ Subtractive <ul style="list-style-type: none"> <li>• Drilling</li> <li>• Sawing</li> <li>• Threading</li> <li>• Filing</li> </ul> </li> <li>□ Forming <ul style="list-style-type: none"> <li>• Vacuum forming</li> <li>• Press forming</li> </ul> </li> <li>□ Joining and assembly <ul style="list-style-type: none"> <li>• Brazing</li> <li>• Riveting</li> <li>• Mechanical fastening</li> <li>• Adhesive</li> </ul> </li> <li>□ Finishing <ul style="list-style-type: none"> <li>• Deburring</li> <li>• Painting</li> <li>• Power coating</li> </ul> </li> </ul> <p>Does not include:</p> <ul style="list-style-type: none"> <li>□ Wood for the prototype component(s), but wood can be used for formers and/or jigs/fixtures where required</li> </ul>

## 4.2 Manufacture an electronic circuit prototype

- Correct use of:
  - Printed Circuit Board (PCB) substrate  
CNC routing/chemical etching or stripboard
  - Soldering techniques
  - Mounting methods for printed circuit boards (PCBs) or stripboard circuits
  - Wiring methods for circuit boards
  - Equipment
  - Tools
- Safe working practices:
  - Correct procedures
  - Risk assessment
  - Appropriate PPE
- Manufacture a prototype using an engineering drawing and planning documentation
- Sustainability considerations

### To include:

- An awareness of IPC soldering standards
  - Soldered joints should not be:
    - Dry
    - Overheated
- Selecting, setting up and using and shutting down engineering processes, equipment and tools to manufacture a circuit using either:
  - A stripboard prototype comprising correctly placed, orientated and soldered components, or
  - A printed circuit board (PCB) producing the copper tracks, drilling, component placement and orientation, soldering
- Processes, equipment and tools used must be appropriate to the task/component
  - PCB drill
  - Soldering iron
  - Lead-free solder
  - Clamp
  - Magnifying glass

Examples of **correct procedures** may include:

- Localised extraction

Examples of **sustainability considerations** may include:

- Reduction of waste including the use of components and consumables and preventing defects
- Minimise energy use
- Recycle waste material.

Does not include:

- Use of breadboards

<b>Topic Area 5: Evaluate a prototype</b>	
<b>Teaching content</b>	<b>Exemplification</b>
<b>5.1 Evaluate a mechanical prototype</b>	
<ul style="list-style-type: none"> <li>□ Visual inspection</li> <li>□ Quantitative inspection</li> </ul>	<p>Examples of <b>quantitative inspection</b> may include:</p> <ul style="list-style-type: none"> <li>□ Measuring the dimensions of the prototype against the engineering drawings and the original physical component</li> <li>□ Positioning of the mechanical features</li> </ul> <p>Examples of visual inspection may include:</p> <ul style="list-style-type: none"> <li>□ quality of the surface finish and material edges</li> </ul>
<b>5.2 Evaluate an electronic circuit prototype</b>	
<ul style="list-style-type: none"> <li>□ Visual inspection</li> <li>□ Functional testing of the circuit in operation using a multimeter</li> <li>□ Working safely with testing equipment</li> </ul>	<p>To include:</p> <ul style="list-style-type: none"> <li>□ Functional testing includes safe use of a multimeter</li> <li>□ Recording of testing showing measured values against expected values</li> <li>□ Review the overall functionality against stated requirements</li> </ul> <p>Examples of <b>visual inspection</b> may include:</p> <ul style="list-style-type: none"> <li>□ Track pads</li> <li>□ Soldered joints</li> <li>□ Orientation of components</li> </ul>

## Assessment criteria

**Section 6.4** provides full information on how to assess the NEA units and apply the assessment criteria.

These are the assessment criteria for the tasks for this unit. The assessment criteria indicate what is required in each task. Students' work must show that all aspects of a criterion have been met in sufficient detail for it to be **successfully achieved** (see **Section 6.4.1**). If a student's work does not fully meet a criterion, you must not award that criterion.

The command words used in the assessment criteria are defined in **Appendix B**.

Pass	Merit	Distinction
<b>P1: Describe</b> the function of the components in the prototype, identifying the materials, type of joints and fixings and finishes used.	<b>M1: Explain</b> how the prototype contributes to the function of the product.	
<b>P2: Measure</b> each component in the prototype using appropriate measurement devices and record the results.		
<b>P3: Produce</b> an appropriate third angle orthographic projection of the non-standard component(s) in the prototype using engineering drawing standards.	<b>M2: Produce</b> an appropriate sectioned/detailed view of <b>one</b> non-standard component from the prototype using engineering drawing standards.	<b>D1: Produce</b> an appropriate isometric assembly projection for the prototype using engineering drawing standards.
<b>P4: Produce</b> a bill of materials for manufacturing the prototype, considering sustainability.	<b>M3: Produce</b> a manufacturing plan for the non-standard component(s) in the prototype, including the correct sequence of operations and use of equipment/tools.	
<b>P5: Produce</b> an appropriate risk assessment for manufacturing the prototype.		
<b>P6: Safely manufacture</b> the non-standard component(s) of the prototype using appropriate hand and machine processes.	<b>M4: Explain</b> how you have considered sustainability in your manufacture of the prototype.	<b>D2: Assemble</b> the components into a workable prototype and integrate it back into the product.
<b>P7: Complete</b> visual and quantitative inspection of the non-standard component(s) in the prototype, recording your dimensions and results.	<b>M5: Analyse</b> the prototype against the engineering drawings and the original product.	<b>D3: Evaluate</b> your planning and manufacture of the prototype.
<b>P8: Produce</b> a CAD drawing of the electronic circuit diagram using engineering drawing standards.		
<b>P9: Simulate</b> the electronic circuit to demonstrate its correct operation.		<b>D4: Use</b> correct methods to measure appropriate values and voltages from the simulated circuit.

Pass	Merit	Distinction
<b>P10: Produce</b> a layout diagram for either a strip board or a printed circuit board substrate.	<b>M6: Explain</b> how you have considered sustainability in your planning of the prototype electronic circuit.	
<b>P11: Produce</b> an appropriate risk assessment for manufacturing the prototype electronic circuit.	<b>M7: Produce</b> a manufacturing plan for the prototype electronic circuit, including the correct sequence of operations and use of equipment/tools.	
<b>P12: Safely manufacture</b> the prototype electronic circuit on stripboard or printed circuit board substrate using appropriate processes and considering sustainability.		
<b>P13: Demonstrate</b> that the prototype electronic circuit operates as required.		
<b>P14: Complete</b> functional testing to safely measure relevant voltages and currents from the prototype circuit in operation and record your results.	<b>M8: Evaluate</b> the prototype electronic circuit you have manufactured using visual inspection.	<b>D5: Analyse</b> the simulated values against the actual values recorded from the physical prototype.
		<b>D6: Evaluate</b> the simulation, planning and manufacturing processes used explaining any improvements you would make.

### Assessment guidance

This assessment guidance gives you information relating to the assessment criteria. There might not be additional assessment guidance for each assessment criterion. It is included only where it is needed.

Assessment Criteria	Assessment Guidance
P1	<ul style="list-style-type: none"> <li>M1 is an extension of P1. Students need to explain how the prototype works in conjunction with other components as part of the overall function of the product.</li> </ul>
M1	
P2	<ul style="list-style-type: none"> <li>Students must use measurement devices which can enable a suitably accurate reading for the type and size of dimension being measured.</li> </ul>
P3	<ul style="list-style-type: none"> <li>An appropriate third angle orthographic projection drawing of <b>all</b> the non-standard component(s) for the prototype is required.</li> <li>The dimensions need to be accurate compared to the physical component.</li> </ul>
M2	<ul style="list-style-type: none"> <li>An appropriate sectioned/detailed view of <b>one</b> of the non-standard components drawn for P3 is required.</li> <li>P3 and M2 combined must be sufficiently detailed to allow a competent third party to manufacture the component(s).</li> </ul>

D1	<ul style="list-style-type: none"> <li>An assembly of all components for the prototype, including standard components, is required.</li> </ul>
P4	<ul style="list-style-type: none"> <li>Students show consideration of sustainability through the selection of appropriate types of material and forms of supply which minimise waste and additional processing.</li> </ul>
P6	<ul style="list-style-type: none"> <li>Teacher observation records should describe whether the processes and equipment/tools were set-up, operated and shutdown appropriately and whether their use was appropriate to the required task.</li> </ul>
M4	<ul style="list-style-type: none"> <li>Evidence is in the form of an explanation. Some aspects of the sustainability considerations may be things observed by the teacher in P6, so the Teacher Observation Record may act as supporting evidence as appropriate.</li> </ul>
D2	<ul style="list-style-type: none"> <li>D2 requires a demonstration that the prototype can be assembled and that it can work with other corresponding parts of the overall product. This could be shown by assembling the prototype into the original whole product, or by combining with other prototypes to assemble a whole product prototype.</li> </ul>
P7	<ul style="list-style-type: none"> <li>Use inspection to measure and record dimensions and results.</li> </ul>
M5	<ul style="list-style-type: none"> <li>Analyse the prototype made against the original product and analysis (task 1) and the drawings produced (task 2), explaining why there are any differences.</li> </ul>
D3	<ul style="list-style-type: none"> <li>Evaluate own performance in the planning and manufacture of the prototype, how well aspects of the processes were followed, and reflect on how this influenced the quality of the final outcome.</li> </ul>
P8	<ul style="list-style-type: none"> <li>The circuit diagram must be an accurate representation of the required circuit and be drawn to meet current engineering drawing standards (e.g. BS 60617).</li> </ul>
P9	<ul style="list-style-type: none"> <li>Students must use simulation to show the function of the circuit to meet the stated requirement(s).</li> </ul>
D4	<ul style="list-style-type: none"> <li>Students need to use correct testing methods and virtual test equipment to generate the results required.</li> </ul>
P12	<ul style="list-style-type: none"> <li>Teacher observation records should describe whether the processes and equipment/tools were set-up, operated and shutdown appropriately and their use was appropriate to the required task, including evidence of sustainability considerations being taken into account.</li> </ul>
P13	<ul style="list-style-type: none"> <li>It is acceptable for any faults found to be corrected in order to be able to show that the prototype electronic circuit works.</li> </ul>
D5	<ul style="list-style-type: none"> <li>The analysis should include a justification of any differences between the simulated values and the actual values.</li> </ul>

## Synoptic assessment

Some of the knowledge, understanding and skills required when completing this unit will draw on the learning developed in unit F130, Principles of engineering, and unit F131, Materials science and technology.

The following table details where these synoptic links can be found:

Unit F132: Engineering in practice		Unit F130: Principles of engineering	
Topic Area		Topic Area	
1	Product analysis	1	Mathematics
		2	Mechanical principles
2	Produce Computer Aided Design (CAD) mechanical and electronic engineering drawings	3	Electrical/electronic principles

Unit F132: Engineering in practice		Unit F131: Materials science and technology	
Topic Area		Topic Area	
1	Product analysis	1	Material properties
4	Manufacturing processes	2	Types of material
		3	Effects of processing techniques on material properties
5	Evaluate a prototype	4	Material failure mechanisms and prevention

More information about synoptic assessment in these qualifications can be found in **Section 5.2 Synoptic assessment**.



### 4.3.2 Unit F133: Computer Aided Design (CAD)

#### Essential resources required for this unit:

- 3D modelling software, e.g. Autodesk inventor, Fusion 360, OnShape, Solidworks.
- Access to software that can do CFD and FEA e.g. inbuilt in software or Simscale.
- Access to screen recording software.

#### Unit Aim

Computer Aided Design has become increasingly prevalent in engineering, with 3D modelling enabling industry to prototype and create their designs at a rate that would have been unprecedented 20 years ago. Entrepreneurs, engineers, and designers use a variety of techniques and simulations to either put their ideas into a digital model or take things that exist, 3D model them and then optimise them using the power of simulation.

In this unit you will learn how to take physical objects and recreate them as a 3D model making individual designs and changes based on developments you make to the model. This will include learning how to use 2D sketch-based functions to create basic geometry that you can control and dimension. You will also learn how to put a design into simulations, allowing you to make conscious design modifications to 3D models to improve them for the consumer.

Unit F133: Computer Aided Design (CAD)	
Topic Area 1: Produce 3D models using Computer Aided Design (CAD)	
Teaching content	Exemplification
<b>1.1 Understanding the uses of CAD</b>	
<b>1.1.1 Using CAD to model real objects in computer software</b> <ul style="list-style-type: none"> <li>□ Measuring objects using measuring devices</li> <li>□ Analysing the structure and identifying aspects that can be individual components</li> </ul>	To include: <ul style="list-style-type: none"> <li>□ A model is a 3D representation of a component</li> <li>□ An assembly is a representation of a group of components that interface together</li> </ul> Examples of <b>measuring devices</b> may include: <ul style="list-style-type: none"> <li>□ Rulers</li> <li>□ Callipers (vernier and digital)</li> <li>□ Micrometres</li> <li>□ Protractors</li> </ul>
<b>1.1.2 Standard components and non-standard components</b> <ul style="list-style-type: none"> <li>□ Standard components library and their uses in CAD modelling</li> <li>□ Non-standard components and their differences with standard components</li> </ul>	Examples of <b>standard components</b> may include: <ul style="list-style-type: none"> <li>□ Screws</li> <li>□ Bolts</li> <li>□ Nuts</li> <li>□ Gears</li> </ul>
<b>1.2 Creating sketch geometry</b>	
<b>1.2.1 Sketch-based features</b> <ul style="list-style-type: none"> <li>□ Extrude, revolve</li> <li>□ Lines, arcs, splines, polygons</li> <li>□ Mirroring</li> <li>□ Offset</li> <li>□ Patterns</li> <li>□ Sizing and dimensioning</li> <li>□ Sketch tools</li> </ul>	Examples of <b>polygons</b> may include: <ul style="list-style-type: none"> <li>□ Triangles</li> <li>□ Squares</li> <li>□ Rectangles</li> <li>□ Hexagons</li> </ul> Examples of <b>patterns</b> may include: <ul style="list-style-type: none"> <li>□ Linear</li> <li>□ Circular</li> </ul>

<p><b>1.2.2 Reference geometry</b></p> <ul style="list-style-type: none"> <li><input type="checkbox"/> Axes, points</li> <li><input type="checkbox"/> Co-ordinate systems</li> <li><input type="checkbox"/> Work planes</li> </ul>	<p>To include:</p> <ul style="list-style-type: none"> <li><input type="checkbox"/> Using extruded faces as sketch planes</li> <li><input type="checkbox"/> Creating work planes from parallel and perpendicular to reference points</li> </ul>
<p><b>1.3 Solid modelling tools used to create 3D shapes</b></p>	
<p><b>1.3.1 Features</b></p> <ul style="list-style-type: none"> <li><input type="checkbox"/> Applied features <ul style="list-style-type: none"> <li>• Fillets</li> <li>• Chamfers</li> <li>• Shelling</li> <li>• Holes</li> <li>• Drafts</li> </ul> </li> <li><input type="checkbox"/> Extrude <ul style="list-style-type: none"> <li>• Addition</li> <li>• Removal</li> </ul> </li> <li><input type="checkbox"/> Mirror tool</li> <li><input type="checkbox"/> Pattern tools</li> <li><input type="checkbox"/> Revolve</li> </ul>	
<p><b>1.3.2 Advanced features</b></p> <ul style="list-style-type: none"> <li><input type="checkbox"/> Swept features <ul style="list-style-type: none"> <li>• Lofted/blended features</li> <li>• Variable section features</li> <li>• Helical sweeps</li> <li>• Sheet metal</li> </ul> </li> </ul>	<p>Examples of <b>variable section features</b> may include:</p> <ul style="list-style-type: none"> <li><input type="checkbox"/> Creating loft/blend</li> <li><input type="checkbox"/> Swept with multiple features</li> </ul> <p>Examples of <b>helical sweeps</b> may include:</p> <ul style="list-style-type: none"> <li><input type="checkbox"/> Springs</li> <li><input type="checkbox"/> Coils</li> <li><input type="checkbox"/> Thread geometry</li> </ul> <p>Examples of <b>sheet metal</b> may include:</p> <ul style="list-style-type: none"> <li><input type="checkbox"/> Folds</li> <li><input type="checkbox"/> Pressings</li> <li><input type="checkbox"/> Flattened geometry</li> </ul>
<p><b>1.3.3 Projected or intersection geometry</b></p> <ul style="list-style-type: none"> <li><input type="checkbox"/> Curves through XYZ or reference points</li> <li><input type="checkbox"/> Intersection curves</li> <li><input type="checkbox"/> Projected curves or sketches</li> </ul>	

<p><b>1.3.4 Surface modelling</b></p> <ul style="list-style-type: none"> <li>□ Advanced curve geometry</li> <li>□ Extruded, revolved, swept and lofted/blended surfaces, boundary surfaces, planar/flat or filled surfaces</li> <li>□ Surface construction geometry</li> <li>□ Thickening of surface models</li> <li>□ The differences between solid and surface modelling</li> <li>□ The uses of surface modelling</li> </ul>	<p>To include:</p> <ul style="list-style-type: none"> <li>□ Combining the features to create external shells of products</li> </ul> <p>Examples of <b>advanced curve geometry</b> may include:</p> <ul style="list-style-type: none"> <li>□ Guide curves</li> <li>□ Intersection curves</li> <li>□ Projected geometry</li> <li>□ Bridging curves</li> </ul> <p>Examples of <b>surface construction</b> may include:</p> <ul style="list-style-type: none"> <li>□ Curves</li> <li>□ Splines</li> </ul> <p>Examples of <b>the uses of surface modelling</b> may include:</p> <ul style="list-style-type: none"> <li>□ Casing for consumer products</li> <li>□ Body panels of vehicles</li> <li>□ Architectural rendering</li> </ul>
<p><b>1.4 Variations and configurations</b></p>	
<p><b>1.4.1 Configurations and table-driven features</b></p> <ul style="list-style-type: none"> <li>□ Configured components and assemblies</li> <li>□ Component geometry driven through formulas and tables</li> <li>□ Product families</li> </ul>	<p>To include:</p> <ul style="list-style-type: none"> <li>□ How an engineer can control the 3D model without going in and out of a sketch or extrude</li> <li>□ How configurations and table-driven features can be used by a customer to alter designs to their specifications</li> </ul> <p>Does not include:</p> <ul style="list-style-type: none"> <li>□ Optimisation of location (advanced mathematics simulation)</li> </ul>
<p><b>1.4.2 Mathematical equations and variables</b></p> <ul style="list-style-type: none"> <li>□ Equations using variables</li> <li>□ Variables</li> </ul>	<p>Examples of <b>equations using variables</b> may include:</p> <ul style="list-style-type: none"> <li>□ Addition</li> <li>□ Subtraction</li> <li>□ Multiplication</li> <li>□ Division</li> </ul> <p>Does not include</p> <ul style="list-style-type: none"> <li>□ Using advanced mathematics to solve reference geometry</li> </ul>

<b>Topic Area 2: Create a 3D assembly of multiple components within a CAD software</b>	
<b>Teaching content</b>	<b>Exemplification</b>
<b>2.1 Aspects of assembly</b>	
<ul style="list-style-type: none"> <li><input type="checkbox"/> Mating components</li> <li><input type="checkbox"/> Multiple component assemblies</li> <li><input type="checkbox"/> Patterning components</li> </ul>	<p>Examples of <b>mating components</b> may include:</p> <ul style="list-style-type: none"> <li><input type="checkbox"/> Fasten</li> <li><input type="checkbox"/> Revolve</li> <li><input type="checkbox"/> Slider</li> <li><input type="checkbox"/> Pivot</li> </ul>
<b>2.2 Presentation of assemblies</b>	
<ul style="list-style-type: none"> <li><input type="checkbox"/> Animation</li> <li><input type="checkbox"/> Exploded views</li> <li><input type="checkbox"/> Mate relations</li> </ul>	<p>To include:</p> <ul style="list-style-type: none"> <li><input type="checkbox"/> Exploded views and animation to allow assemblies to be seen built or working</li> </ul> <p>Examples of <b>mate relations</b> may include:</p> <ul style="list-style-type: none"> <li><input type="checkbox"/> Gear</li> <li><input type="checkbox"/> Rack and pinion</li> <li><input type="checkbox"/> Screw</li> <li><input type="checkbox"/> Linear</li> </ul>
<b>Topic Area 3: Creating technical drawings from 3D models</b>	
<b>Teaching content</b>	<b>Exemplification</b>
<b>3.1 Drawing standards and conventions</b>	
<ul style="list-style-type: none"> <li><input type="checkbox"/> Engineering drawing standards (BS 8888) for presentation of information on technical drawings <ul style="list-style-type: none"> <li>● Nesting of dimensions</li> <li>● Orientation of dimensions</li> <li>● Layout of drawings</li> <li>● Labelling of components</li> <li>● Titling</li> </ul> </li> </ul>	
<b>3.2 How to use projection and units</b>	
<ul style="list-style-type: none"> <li><input type="checkbox"/> First and third angle orthographic projection <ul style="list-style-type: none"> <li>● Section views</li> <li>● Detailed views</li> <li>● Auxiliary views</li> <li>● Isometric views</li> <li>● Scale</li> </ul> </li> </ul>	<p>Examples of <b>third angle orthographic</b> views may include:</p> <ul style="list-style-type: none"> <li><input type="checkbox"/> Top view</li> <li><input type="checkbox"/> Appropriate side view</li> <li><input type="checkbox"/> Front view</li> </ul>
<b>3.3 Apply dimensioning and annotations</b>	
<p>Apply dimensioning and annotations</p> <ul style="list-style-type: none"> <li><input type="checkbox"/> Dimensioning styles</li> <li><input type="checkbox"/> Manufacturing information</li> <li><input type="checkbox"/> Callouts and labels</li> </ul>	<p>Examples of <b>dimensioning styles</b> may include:</p> <ul style="list-style-type: none"> <li><input type="checkbox"/> Linear</li> <li><input type="checkbox"/> Polar</li> <li><input type="checkbox"/> Baseline</li> </ul> <p>Examples of <b>manufacturing information</b> may include:</p> <ul style="list-style-type: none"> <li><input type="checkbox"/> Surface finish</li> <li><input type="checkbox"/> Weld symbols</li> <li><input type="checkbox"/> Fit and tolerances</li> </ul>

<b>3.4 Assembly drawings</b>	
<b>3.4.1 Tables and balloons</b>	
<ul style="list-style-type: none"> <li><input type="checkbox"/> Bill of Materials (BOM)</li> <li><input type="checkbox"/> Components lists</li> <li><input type="checkbox"/> Use of standard components and non-standard components</li> </ul>	
<b>3.4.2 Views</b>	
<ul style="list-style-type: none"> <li><input type="checkbox"/> Exploded views</li> <li><input type="checkbox"/> Sub-assemblies</li> </ul>	
<b>Topic Area 4: Simulations in 3D modelling</b>	
<b>Teaching content</b>	<b>Exemplification</b>
<b>4.1 Simulations in 3D modelling</b>	
<b>4.1.1 Types of simulation</b>	
<ul style="list-style-type: none"> <li><input type="checkbox"/> Finite element analysis (FEA)</li> <li><input type="checkbox"/> Computational fluid dynamics (CFD)</li> </ul>	<p>To include:</p> <ul style="list-style-type: none"> <li><input type="checkbox"/> An outline of how the simulation works</li> </ul> <p>Examples of the application of <b>FEA</b> may include:</p> <ul style="list-style-type: none"> <li><input type="checkbox"/> Stress</li> <li><input type="checkbox"/> Vibration</li> <li><input type="checkbox"/> Fatigue</li> </ul> <p>Examples of the application of <b>CFD</b> may include:</p> <ul style="list-style-type: none"> <li><input type="checkbox"/> Liquids</li> <li><input type="checkbox"/> Gases</li> </ul>
<b>4.2 Setting up and running simulations</b>	
<ul style="list-style-type: none"> <li><input type="checkbox"/> Mesh setup</li> <li><input type="checkbox"/> Operating conditions</li> <li><input type="checkbox"/> Finite element analysis (FEA) including: <ul style="list-style-type: none"> <li>• Material properties</li> <li>• External forces</li> <li>• Boundary conditions <ul style="list-style-type: none"> <li>○ Fixed points</li> </ul> </li> </ul> </li> </ul>	<p>Examples of <b>operating conditions</b> may include:</p> <ul style="list-style-type: none"> <li><input type="checkbox"/> Human forces</li> <li><input type="checkbox"/> Flow of water</li> <li><input type="checkbox"/> Flow of air</li> <li><input type="checkbox"/> Machine interaction</li> </ul> <p>Examples of <b>external forces</b> may include:</p> <ul style="list-style-type: none"> <li><input type="checkbox"/> Pressure</li> <li><input type="checkbox"/> Torque</li> <li><input type="checkbox"/> Forces</li> <li><input type="checkbox"/> Temperature</li> </ul> <p>Examples of <b>flow type</b> may include:</p> <ul style="list-style-type: none"> <li><input type="checkbox"/> Incompressible</li> <li><input type="checkbox"/> Compressible</li> </ul> <p>Examples of <b>boundary conditions in CFD</b> include:</p> <ul style="list-style-type: none"> <li><input type="checkbox"/> Inlets</li> <li><input type="checkbox"/> Outlets</li> <li><input type="checkbox"/> Walls</li> </ul>

	<p>Does not include:</p> <ul style="list-style-type: none"> <li><input type="checkbox"/> Any other types of simulation to complete</li> </ul>
<b>4.3 Analysing results of simulations</b>	
<ul style="list-style-type: none"> <li><input type="checkbox"/> Interpretation of results from <ul style="list-style-type: none"> <li>• FEA</li> <li>• von Mises stress</li> <li>• Displacement</li> </ul> </li> <li><input type="checkbox"/> CFD simulations</li> <li><input type="checkbox"/> Streamlines</li> </ul>	<p>To include:</p> <ul style="list-style-type: none"> <li><input type="checkbox"/> Analysing contour plots for FEA and Von Mises stress</li> <li><input type="checkbox"/> CFD definition of turbulent and laminar flow</li> <li><input type="checkbox"/> CFD streamline animations</li> </ul> <p>Does not include:</p> <ul style="list-style-type: none"> <li><input type="checkbox"/> Other types of results from FEA or CFD at this level</li> </ul>
<b>4.4 Engineering principles of design</b>	
<ul style="list-style-type: none"> <li><input type="checkbox"/> Using information from simulation analysis/model image to make justified design changes to an object</li> </ul>	<p>To include:</p> <ul style="list-style-type: none"> <li><input type="checkbox"/> Changes due to <ul style="list-style-type: none"> <li>• Ergonomics</li> <li>• Aesthetics</li> <li>• Fluid flow/friction</li> </ul> </li> <li><input type="checkbox"/> Structural integrity for intended use, such as rounding of corners and other changes to the component geometry</li> <li><input type="checkbox"/> Factor of safety in terms of load/stress distribution</li> </ul> <p>Does not include:</p> <ul style="list-style-type: none"> <li><input type="checkbox"/> Financial or costing constraints</li> <li><input type="checkbox"/> Colour as component of aesthetics</li> <li><input type="checkbox"/> Material types</li> </ul>

## Assessment criteria

**Section 6.4** provides full information on how to assess the NEA units and apply the assessment criteria.

These are the assessment criteria for the tasks for this unit. The assessment criteria indicate what is required in each task. Students' work must show that all aspects of a criterion have been met in sufficient detail for it to be **successfully achieved** (see **Section 6.4.1**). If a student's work does not fully meet a criterion, you must not award that criterion.

The command words used in the assessment criteria are defined in **Appendix B**.

Pass	Merit	Distinction
<b>P1: Produce</b> an appropriate 2D sketch using dimensions from the product.	<b>M1: Use</b> appropriate variables or equations in a sketch or extrude.	<b>D1: Produce</b> a surface model of a component of the design using appropriate tools and techniques.
<b>P2: Use</b> the pattern tool within a sketch of a component.	<b>M2: Use</b> advanced features that involve multiple planes and sketches.	<b>D2: Produce</b> a to scale, complete, animated 3D assembly of the physical product.
<b>P3: Use</b> a mirror tool in a sketch of a component.		
<b>P4: Use</b> extrude and revolve tools in a sketch of a component.	<b>M3: Produce</b> an exploded view of a 3D assembly.	
<b>P5: Use</b> applied features to add details to a 3D model of a component.		
<b>P6: Produce</b> a 3D assembly of at least <b>six</b> interfacing non-standard components.		
<b>P7: Use</b> constraints within an assembly that appropriately define the position or movement of the components within the model.		
<b>P8: Produce</b> an orthographic technical drawing with more than one view of a non-standard component within a 3D assembly.	<b>M4: Apply</b> accurate dimensioning and annotations to a technical drawing.	

Pass	Merit	Distinction
<p><b>P9: Set up</b> an appropriate simulation for the assembly, using the operating conditions given.</p>	<p><b>M5: Conclude</b> the results of the simulation of an assembly.</p>	<p><b>D4: Recommend</b> alternative design ideas based on the results of the simulation.</p>
<p><b>P10: Complete</b> a simulation for the assembly to produce appropriate results.</p>		
<p><b>P11: Create</b> an alternative design for a component of the assembly.</p>	<p><b>M6: Use</b> table-driven features or configurations in designs to create variable designs of a component or assembly.</p>	<p><b>D5 Evaluate</b> whether the alternative design is an improvement using simulation software and design principles.</p>

DRAFT



## Assessment guidance

This assessment guidance gives you information relating to the assessment criteria. There might not be additional assessment guidance for each assessment criterion. It is included only where it is needed.

Assessment Criteria	Assessment guidance
P1	<ul style="list-style-type: none"> <li>It is not necessary to disassemble the product to complete any of the tasks.</li> </ul>
P6	<ul style="list-style-type: none"> <li>P6 can be achieved with an assembly of at least six interfacing non-standard components. It may not have to be an assembly of the whole product (depending on the product in the assignment).</li> <li>However more than six non-standard components may be needed to produce a 3D assembly of the whole product, which is required for D2.</li> </ul>
D2	
P8	<ul style="list-style-type: none"> <li>This must be one technical drawing of one non-standard component within the assembly which includes multiple views of that component. It does not have to be dimensioned or annotated but must have a scale.</li> </ul>
M4	<ul style="list-style-type: none"> <li>Applying annotations, callouts and dimensions to a component (P8) or assembly (D3) technical drawing.</li> </ul>
D3	<ul style="list-style-type: none"> <li>The technical assembly drawing must be produced using an appropriate drawing standard, such as British Standard (BS) 8888.</li> <li>Correct nesting and orientation of dimensions, labels and callout boxes must be demonstrated. Presentation of the assembly must also conform to the standard and may include different views if they are appropriate.</li> </ul>
P9/10	<ul style="list-style-type: none"> <li>Where possible the assembly already produced should be used. However, where an assembly was not successfully created one can be provided by the teacher for the student to use when trying to meet these assessment criteria.</li> </ul>
M5	<ul style="list-style-type: none"> <li>Students must draw appropriate conclusions from their simulation results about the performance of the components and/or assembly under the given operating conditions.</li> </ul>
P11	<ul style="list-style-type: none"> <li>Evidence of a change in the model should be provided, along with documentation about what was changed and how it affects the model. The alternative design must be a noticeable change to the geometry of at least one component.</li> </ul>
M6	<ul style="list-style-type: none"> <li>This is to demonstrate that the model can be altered, but in such a way that it is table driven. For example, a client can control it from a table (depending on software) to alter the design.</li> </ul>
D4	<ul style="list-style-type: none"> <li>The alternative design ideas must each have a noticeable change to the geometry of at least one component. The ideas could be applied to the same component, or to different components.</li> </ul>
D5	<ul style="list-style-type: none"> <li>This must include a response to the simulation results, alterations to the design, a retest and justifications of the change made. The criteria can still be met if the change does not lead to an improvement in the model. However, justification for the change, showing understanding of the simulation and design principles, would be needed.</li> </ul>

## Synoptic assessment

Some of the knowledge, understanding and skills needed to complete this unit will draw on the learning in Unit F130: Principles of engineering, and Unit F131: Materials science and technology.

This table details these synoptic links.

Unit F133: Computer Aided Design (CAD)		Unit F130: Principles of engineering	
Topic Area		Topic Area	
1	Understanding the uses of CAD	1	Mathematics
4	Simulations in 3D modelling	2	Mechanical principles

Unit F133: Computer Aided Design (CAD)		Unit F131: Material science and technology	
Topic Area		Topic Area	
4	Simulations in 3D modelling	1	Material properties

More information about synoptic assessment in these qualifications can be found in **Section 5.2 Synoptic assessment**.

### 4.3.3 Unit F134: Programmable electronics

#### Essential resources required for this unit:

- Access to appropriate virtual modelling and program simulation software is required

#### Unit Aim

Programmable electronic systems are all around us. From the smart phones in our pockets, the computer sensor systems in cars, to the technologies that control large scale manufacturing processes, they play an ever more important role in our everyday lives. As this sector continues to grow there will be an increasing demand for engineers capable of designing, assembling, and programming these essential systems.

In this unit you will learn about the different types of programmable electronic devices and their applications. You will learn how to use input and output devices in programmable systems, and how to produce representations of them. You will also learn how to make models and prototypes of these systems to check how they would work. You will develop your assembly, testing and programming skills in order to produce working systems.

<b>Unit F134: Programmable electronics</b>	
<b>Topic Area 1: Microcontrollers and microcontroller systems</b>	
<b>Teaching content</b>	<b>Exemplification</b>
<b>1.1 Microcontroller types for different applications</b>	
<ul style="list-style-type: none"> <li>□ Types of microcontrollers               <ul style="list-style-type: none"> <li>• Peripheral interface controller (PIC)</li> <li>• AVR</li> <li>• ARM</li> <li>• 8051</li> </ul> </li> <li>□ Microcontroller casings               <ul style="list-style-type: none"> <li>• Dual in-line (DIL)</li> <li>• Surface mount (SMT)</li> </ul> </li> </ul>	<p>To include:</p> <ul style="list-style-type: none"> <li>□ Appropriate microcontroller types and casings based on:               <ul style="list-style-type: none"> <li>• The environment for use</li> <li>• Their characteristics and architecture</li> <li>• Relative advantages and disadvantages for use in different applications                   <ul style="list-style-type: none"> <li>○ Commercial</li> <li>○ Prototype</li> </ul> </li> </ul> </li> <li>□ Potential future design requirements</li> </ul>
<b>1.2 Microcontroller systems and programming languages for different applications</b>	
<ul style="list-style-type: none"> <li>□ Systems               <ul style="list-style-type: none"> <li>• PICAXE</li> <li>• GENIE</li> <li>• Arduino</li> <li>• Raspberry Pi Pico</li> </ul> </li> <li>□ Languages               <ul style="list-style-type: none"> <li>• BASIC</li> <li>• MicroPython/Python</li> <li>• C-based languages</li> </ul> </li> </ul>	<p>To include:</p> <ul style="list-style-type: none"> <li>□ Microcontroller systems with in-circuit programming capability</li> <li>□ The suitability of microcontroller systems and programming languages for different applications</li> <li>□ Appropriate microcontroller systems and text-based programming languages based on:               <ul style="list-style-type: none"> <li>• Their function</li> <li>• Relative advantages and disadvantages for use in different applications                   <ul style="list-style-type: none"> <li>○ Commercial</li> <li>○ Prototype</li> </ul> </li> </ul> </li> <li>□ Selecting programming languages that support the range of constructs outlined in topic 4.1</li> </ul>

	<ul style="list-style-type: none"> <li>□ Potential future design requirements</li> </ul> <p>Does not include:</p> <ul style="list-style-type: none"> <li>□ Microcontroller systems that do not have in-circuit programming capability</li> <li>□ Flowchart-based, visual block-based and ladder/graphic-logic based programming languages</li> </ul>
<b>Topic Area 2: Using input and output devices and other electronic components in microcontroller systems</b>	
<b>Teaching content</b>	<b>Exemplification</b>
<b>2.1 Using input and output devices in microcontroller systems</b>	
<b>2.1.1 Input devices</b> <ul style="list-style-type: none"> <li>□ Light sensors</li> <li>□ Temperature sensors</li> <li>□ Moisture/humidity sensors</li> <li>□ Pressure sensors</li> <li>□ Accelerometers</li> <li>□ Proximity sensors <ul style="list-style-type: none"> <li>• Infrared</li> <li>• Ultrasonic</li> <li>• Optical</li> <li>• Magnetic</li> </ul> </li> <li>□ Tilt sensors</li> <li>□ Vibration sensors</li> <li>□ Infrared sensors</li> <li>□ Switches</li> </ul>	<p>To include:</p> <ul style="list-style-type: none"> <li>□ Appropriate input devices for use in programmable systems, depending on: <ul style="list-style-type: none"> <li>• The design brief</li> <li>• Specification requirements</li> <li>• User interfaces for: <ul style="list-style-type: none"> <li>○ Customers</li> <li>○ Operators</li> </ul> </li> </ul> </li> <li>□ Using input devices in programmable electronic systems to detect and measure changes in the environment around them</li> <li>□ How input devices are used with output devices and other components to provide user interfaces</li> </ul> <p>Does not include:</p> <ul style="list-style-type: none"> <li>□ Detecting or measuring environmental changes outside of what the stated input devices are capable of measuring</li> </ul>
<b>2.1.2 Output devices</b> <ul style="list-style-type: none"> <li>□ Light/visual outputs <ul style="list-style-type: none"> <li>• Lamps</li> <li>• Light emitting diodes (LEDs)</li> <li>• Twin digit 7-segment display</li> <li>• Liquid crystal display (LCD)</li> </ul> </li> <li>□ Sound outputs <ul style="list-style-type: none"> <li>• Buzzers</li> <li>• Piezo sounders</li> </ul> </li> <li>□ Movement outputs <ul style="list-style-type: none"> <li>• DC motors</li> <li>• Servo motors</li> <li>• Stepper motors</li> <li>• Solenoids</li> <li>• Relays</li> </ul> </li> </ul>	<p>To include:</p> <ul style="list-style-type: none"> <li>□ Appropriate output devices for use in programmable systems, depending on: <ul style="list-style-type: none"> <li>• The design brief</li> <li>• Specification requirements</li> <li>• User interfaces for: <ul style="list-style-type: none"> <li>○ Customers</li> <li>○ Operators</li> </ul> </li> </ul> </li> <li>□ Using output devices in programmable electronic systems to produce light, sound and movement</li> <li>□ How output devices are used with input devices and other components to provide user interfaces</li> </ul> <p>Does not include:</p> <ul style="list-style-type: none"> <li>□ Producing output signals outside of the stated device capability</li> </ul>

<b>2.2 Using components other than input and output devices in programmable systems</b>	
<b>Components</b> <ul style="list-style-type: none"> <li>□ Resistors</li> <li>□ Capacitors</li> <li>□ Transistors</li> <li>□ Motor driver integrated circuit chips (ICs)</li> <li>□ Download sockets</li> <li>□ Power supplies</li> <li>□ Jumper wires</li> </ul>	<b>To include:</b> <ul style="list-style-type: none"> <li>□ Selecting and justifying appropriate components for use in programmable systems, depending on the design brief and specification criteria given</li> <li>□ Using components in programmable electronic systems according to their function</li> <li>□ Using transistors as drivers in programmable systems</li> <li>□ Using motor driver ICs in programmable systems to control the speed and direction of motors</li> <li>□ How other components are used with input and output devices to provide user interfaces</li> </ul>
<b>Topic Area 3: Designing, developing, and assembling microcontroller-based programmable systems</b>	
<b>Teaching content</b>	<b>Exemplification</b>
<b>3.1 Designing and developing microcontroller-based systems</b>	
<b>3.1.1 Diagrams representing microcontroller-based systems</b> <ul style="list-style-type: none"> <li>□ Block diagrams <ul style="list-style-type: none"> <li>• Input, process and output blocks</li> <li>• Signal arrows</li> <li>• Feedback</li> <li>• Summing points</li> </ul> </li> <li>□ Flowcharts</li> <li>□ Hardware schematics/circuit diagrams</li> </ul>	<b>To include:</b> <ul style="list-style-type: none"> <li>□ Programmable electronic systems with a <b>maximum</b> of: <ul style="list-style-type: none"> <li>• Three types of input devices</li> <li>• Three types of output devices</li> <li>• Five types of input/output devices in total</li> </ul> </li> <li>□ Drawing block diagrams of both open and closed loop programmable systems</li> <li>□ Drawing schematics and circuit diagrams of programmable systems using standard symbols</li> <li>□ Drawing flowcharts to show how designs for programmable systems function</li> </ul> <b>Does not include:</b> <ul style="list-style-type: none"> <li>□ Programmable systems with more than 3 types of input devices, more than 3 types of output devices and more than 5 types of input and output devices in total</li> </ul>

<p><b>3.1.2 Methods of modelling and simulating microcontroller-based systems</b></p> <ul style="list-style-type: none"> <li>□ Breadboards</li> <li>□ Modular systems kits</li> <li>□ Virtual models and simulations</li> </ul>	<p>To include:</p> <ul style="list-style-type: none"> <li>□ Modelling and simulating systems with a <b>maximum</b> of: <ul style="list-style-type: none"> <li>• Three types of input devices</li> <li>• Three types of output devices</li> <li>• Five types of input/output devices in total</li> </ul> </li> <li>□ Using breadboards and modular systems kits to make non-permanent physical models and prototypes of programmable electronic systems</li> <li>□ Using CAD software to create virtual models and simulations of programmable system hardware and software</li> </ul> <p>Does not include:</p> <ul style="list-style-type: none"> <li>□ Programmable systems with more than 3 types of input devices, more than 3 types of output devices and more than 5 types of input and output devices in total</li> </ul>
<p><b>3.2 Assembling and testing microcontroller-based systems</b></p>	
<p><b>3.2.1 Assembly methods and techniques using the microcontrollers and microcontroller</b></p> <ul style="list-style-type: none"> <li>□ Selecting appropriate methods of connecting input devices, output devices and power supplies to programmable systems</li> <li>□ Physically connecting input devices, output devices and power supplies to programmable systems</li> </ul>	<p>To include:</p> <ul style="list-style-type: none"> <li>□ Assembly methods and techniques using the systems listed in Topic Area 1</li> <li>□ Assembling programmable electronic systems with a <b>maximum</b> of: <ul style="list-style-type: none"> <li>• Three types of input devices</li> <li>• Three types output devices</li> <li>• Five types of input/output devices in total</li> </ul> </li> <li>□ Creating user interfaces</li> <li>□ Following safety precautions when assembling programmable systems</li> <li>□ Selecting and using appropriate methods of connection: <ul style="list-style-type: none"> <li>• Crocodile clips</li> <li>• Wires with screw connections</li> <li>• Terminal blocks</li> <li>• Plugs and sockets</li> </ul> </li> </ul> <p>Does not include:</p> <ul style="list-style-type: none"> <li>□ Programmable systems with more than 3 types of input devices, more than 3 types of output devices and more than 5 types of input and output devices in total</li> <li>□ Manufacturing printed circuit boards</li> <li>□ Soldering components to printed circuit boards</li> </ul>

<p><b>3.2.2 Methods of testing microcontroller-based systems</b></p> <ul style="list-style-type: none"> <li>□ Visual inspection</li> <li>□ Functional testing</li> <li>□ Integrated testing of hardware and program code together</li> </ul>	<p>To include:</p> <ul style="list-style-type: none"> <li>□ Visual inspection of input, output and power supply connections</li> <li>□ Following safety precautions when using measurement and test equipment</li> <li>□ Functionally testing against the specification requirements</li> <li>□ Measuring voltage, current and resistance</li> <li>□ Recording results of testing</li> </ul>
<b>Topic Area 4: Programming microcontrollers</b>	
<b>Teaching content</b>	<b>Exemplification</b>
<b>4.1 Producing programs for microcontrollers</b>	
<p>Programming constructs</p> <ul style="list-style-type: none"> <li>□ Sequence</li> <li>□ Selection</li> <li>□ Iteration</li> <li>□ Definite</li> <li>□ Indefinite</li> <li>□ Logic and arithmetic</li> <li>□ Subroutines and functions</li> <li>□ Input/output parameters</li> <li>□ Annotating and structuring the code</li> </ul>	<p>To include:</p> <ul style="list-style-type: none"> <li>□ Producing programs using at least one of the systems and languages in Topic Area 1</li> <li>□ Producing programs that integrate user interfaces into systems</li> <li>□ Using a suitable integrated development environment (IDE) to produce text-based programs for programmable systems</li> <li>□ Using programmable constructs when producing programs for programmable electronic systems: <ul style="list-style-type: none"> <li>• If</li> <li>• Else</li> <li>• Switch</li> <li>• Case</li> <li>• For</li> <li>• Do</li> <li>• While</li> <li>• Timing</li> <li>• Interrupts</li> <li>• Subroutines/functions</li> </ul> </li> <li>□ Using code libraries</li> <li>□ Purpose of annotating and structuring code: <ul style="list-style-type: none"> <li>• To help understanding of code for future maintenance and modification</li> <li>• Fault finding</li> </ul> </li> </ul> <p>Does not include:</p> <ul style="list-style-type: none"> <li>□ Using flowchart-based, visual block-based and ladder/graphic-logic based programming languages</li> </ul>

4.2 Simulating and downloading programs for microcontrollers	
Simulating and downloading programs <ul style="list-style-type: none"> <li>□ Compiling program code</li> <li>□ Program simulation</li> <li>□ Error/fault finding</li> <li>□ Functional testing of downloaded programs</li> </ul>	To include: <ul style="list-style-type: none"> <li>□ Using a suitable integrated development environment (IDE) to simulate program functionality and check for logical and syntax errors</li> <li>□ Downloading programs onto programmable devices and checking this has completed successfully</li> <li>□ Checking that the program controls the system hardware as expected</li> <li>□ Recording results of testing</li> </ul>

### Assessment criteria

**Section 6.4** provides full information on how to assess the NEA units and apply the assessment criteria.

These are the assessment criteria for the tasks for this unit. The assessment criteria indicate what is required in each task. Students' work must show that all aspects of a criterion have been met in sufficient detail for it to be **successfully achieved** (see **Section 6.4.1**). If a student's work does not fully meet a criterion, you must not award that criterion.

The command words used in the assessment criteria are defined in **Appendix B**.

Pass	Merit	Distinction
<b>P1: Analyse</b> appropriate microcontroller types and casings for the commercial application.	<b>M1: Justify</b> the selection of a suitable microcontroller type, casing, system and programming language.	<b>D1: Explain</b> how the selected microcontroller type, casing, system and programming language could be future proofed against new requirements.
<b>P2: Analyse</b> appropriate microcontroller systems and programming languages for the commercial application.		
<b>P3: Select</b> input and output devices and other components for a prototype microcontroller system that meet the specification requirements.	<b>M2: Explain</b> how the devices and other components provide an appropriate user interface to meet the specification requirements.	<b>D2: Justify</b> the selection of input devices, output devices and other components to meet the specification requirements.
<b>P4: Produce</b> an outline program design using a block diagram or flowchart for the prototype showing the main inputs, processes and outputs.	<b>M3: Produce</b> a model or simulate element(s) of the microcontroller system in operation; making improvements and/or repairs as required.	



Pass	Merit	Distinction
<b>P5: Produce</b> an appropriate hardware schematic/circuit diagram of the prototype system.		
<b>P6: Assemble</b> the hardware devices safely for the prototype.		
<b>P7 Explain</b> how the prototype will be tested to ensure the specification requirements are met.		
<b>P8: Produce</b> the program code for the prototype using constructs.	<b>M4: Use</b> appropriate annotation of the program code to communicate how the program works.	<b>D3: Produce</b> code which is well organised, efficient and correctly uses appropriate constructs.
	<b>M5: Simulate</b> the hardware and program code in operation, correcting logical and syntax errors.	
<b>P9: Compile</b> and download the program code onto a microcontroller.		
<b>P10: Complete</b> visual inspection and functional testing of the prototype system in operation.		<b>D4: Complete</b> integrated testing of the hardware and program code, repairing errors in the microcontroller system.
<b>P11: Demonstrate</b> how the operation of the prototype microcontroller system meets the <b>minimum requirements</b> of the specification.	<b>M6: Demonstrate</b> how the operation of the prototype microcontroller system meets the <b>additional requirements</b> of the specification.	<b>D5: Conclude</b> how well the microcontroller system in operation meets all the requirements of the specification.

## Assessment guidance

This assessment guidance gives you information relating to the assessment criteria. There might not be additional assessment guidance for each assessment criterion. It is included only where it is needed.

Assessment Criteria	Assessment guidance
All	<ul style="list-style-type: none"> <li>The system to be assembled is a low voltage prototype that must meet the requirements of a given brief and specification. Only the input and output devices as listed in the unit content need to be used. For example, for a traffic light system a set of coloured LEDs should be used rather than a set of actual traffic lights.</li> <li>Component data sheets and library codes may be used when completing the assessment. Access to appropriate virtual modelling and program simulation software is required.</li> <li>Microcontroller programs must be written using an appropriate text-based language. Aim for no more than 100 lines of code as a guide, although programs that are longer than this will not be penalised.</li> </ul>
P7	<ul style="list-style-type: none"> <li>The test record sheet template provided in the assignments can be used to show how the prototype will be tested, as well as for recording the results of testing.</li> </ul>
M3	<ul style="list-style-type: none"> <li>The production of a model or simulation of elements of the microcontroller system in operation is required, with any necessary improvements made. As a minimum this must involve showing the program being simulated, with the operational outcomes of the main parts of the code clearly shown. If no improvements are necessary (i.e. the program works first time) then this needs to be explained, with a justification as to why no improvements are required.</li> </ul>
M4	<ul style="list-style-type: none"> <li>The purpose of the annotation is to demonstrate understanding of the key parts of the program code and constructs that have been used, and to allow a competent third party to amend/maintain the code.</li> </ul>
P11/M6	<ul style="list-style-type: none"> <li>The audio-visual recording only needs to be long enough to show the system working. The maximum recommended length of the audio-visual recording is 3-5 minutes.</li> </ul>

## Synoptic assessment

Some of the knowledge, understanding and skills required when completing this unit will draw on the learning developed in unit F130, Principles of engineering.

The following table details where these synoptic links can be found:

Unit F134: Programmable electronics		Unit F130: Engineering principles	
Topic Area		Topic Area	
2	Using input and output devices and other electronic components in microcontroller systems	3	Electrical/electronic principles
3	Designing, developing, and assembling microcontroller-based programmable systems	1	Mathematics
		3	Electrical/electronic principles
4	Programming microcontrollers	3	Electrical/electronic principles

More information about synoptic assessment in these qualifications can be found in **Section 5.2 Synoptic assessment.**

### 4.3.4 Unit F135: Mechanical product design

#### Unit Aim

Much of the design work you will encounter in engineering is centred around adapting or improving an existing product. As such, a detailed product analysis is often an important part of the research and analysis phase of the design process. Lessons learned here help to ensure that the final design proposal incorporates new materials, processes and design features while also retaining all that was good about the original product.

In this unit you will learn how to analyse and disassemble existing products safely to unlock their design secrets. You will investigate how they work, the materials used, and the processes used in their manufacture. You will then learn the methodology and techniques needed to redesign an existing product to meet the requirements of a given brief and create rendered 3D drawings to present design solutions.

Unit F135: Mechanical product design	
Topic Area 1: Product analysis	
Teaching content	Exemplification
<b>1.1 Product research</b>	
<ul style="list-style-type: none"> <li><input type="checkbox"/> Sources of information               <ul style="list-style-type: none"> <li>• Operating instructions</li> <li>• Product datasheets</li> <li>• Safety instructions</li> <li>• Manufacturer's website</li> </ul> </li> <li><input type="checkbox"/> Product function (what it does)</li> <li><input type="checkbox"/> Product operating principles (how it works)</li> </ul>	<p>To include:</p> <ul style="list-style-type: none"> <li><input type="checkbox"/> An explanation of the electro-mechanical systems incorporated into a product that enable it to function</li> </ul>
<b>1.2 Disassembly</b>	
<ul style="list-style-type: none"> <li><input type="checkbox"/> Safe working practices</li> <li><input type="checkbox"/> Hand tools and equipment</li> <li><input type="checkbox"/> Removal of non-permanent and semi-permanent fasteners</li> <li><input type="checkbox"/> Difference between standard and non-standard components</li> <li><input type="checkbox"/> Documenting the disassembly process to allow reassembly</li> <li><input type="checkbox"/> Component storage, organisation and labelling</li> </ul>	<p>To include:</p> <ul style="list-style-type: none"> <li><input type="checkbox"/> Standard components are bought-in and manufactured in high volumes for many different products and include fasteners</li> <li><input type="checkbox"/> Non-standard components are manufactured specifically for use in the product being manufactured</li> <li><input type="checkbox"/> Hand tools:               <ul style="list-style-type: none"> <li>• Screwdrivers                   <ul style="list-style-type: none"> <li>○ Flat</li> <li>○ Philips</li> <li>○ Pozi-drive</li> </ul> </li> <li>• Hammers                   <ul style="list-style-type: none"> <li>○ Soft faced</li> <li>○ Ball peen</li> </ul> </li> <li>• Pliers                   <ul style="list-style-type: none"> <li>○ Combination</li> <li>○ Circlip</li> </ul> </li> <li>• Pin punches</li> <li>• Spanners</li> <li>• Sockets</li> <li>• Hexagon keys</li> </ul> </li> <li><input type="checkbox"/> Power tools               <ul style="list-style-type: none"> <li>• Cordless drill</li> </ul> </li> </ul>

	<p>Examples of <b>standard components</b> may include:</p> <ul style="list-style-type: none"> <li><input type="checkbox"/> Split and clevis pins</li> <li><input type="checkbox"/> Nuts</li> <li><input type="checkbox"/> Bolts</li> <li><input type="checkbox"/> Washers</li> <li><input type="checkbox"/> Screws</li> <li><input type="checkbox"/> Circlips</li> <li><input type="checkbox"/> Pop rivets</li> <li><input type="checkbox"/> Springs</li> <li><input type="checkbox"/> Bearings</li> <li><input type="checkbox"/> Seals</li> </ul> <p>Does not include:</p> <ul style="list-style-type: none"> <li><input type="checkbox"/> Operation of the product</li> <li><input type="checkbox"/> Destructive techniques that would rule out re-assembly</li> <li><input type="checkbox"/> Soldered or folded joints</li> </ul>
<p><b>1.3 Identification of materials</b></p>	
<ul style="list-style-type: none"> <li><input type="checkbox"/> Investigating materials used in manufactured (non-standard) components: <ul style="list-style-type: none"> <li>• Manufacturers' information</li> <li>• Material recycling identification symbols</li> <li>• Component performance requirements</li> <li>• Material compatibility with known manufacturing processes</li> <li>• Basic workshop non-destructive testing</li> <li>• Material properties</li> <li>• Identifying materials from component requirements</li> </ul> </li> <li><input type="checkbox"/> Justifying the use of the material used to manufacture non-standard components</li> </ul>	<p>To include:</p> <ul style="list-style-type: none"> <li><input type="checkbox"/> Basic workshop non-destructive tests: <ul style="list-style-type: none"> <li>• Scratch test for hardness</li> <li>• Magnet test for ferrous metals</li> <li>• Hot needle test to differentiate between thermoplastic and thermosetting polymers</li> </ul> </li> </ul> <p>Does not include:</p> <ul style="list-style-type: none"> <li><input type="checkbox"/> Destructive tests</li> </ul>

<b>1.4 Identification of manufacturing processes</b>	
<ul style="list-style-type: none"> <li>□ Investigating processes used to manufacture non-standard components <ul style="list-style-type: none"> <li>• Component features indicative of particular manufacturing processes: <ul style="list-style-type: none"> <li>○ Ejector marks</li> <li>○ Seams</li> <li>○ Sprues</li> <li>○ Witness marks</li> </ul> </li> <li>• Process compatibility with known component material</li> <li>• Identifying processes from component characteristics <ul style="list-style-type: none"> <li>○ Surface finish</li> <li>○ Shape and complexity</li> <li>○ Dimensional tolerances</li> </ul> </li> </ul> </li> <li>□ Justifying the use of the process(es) used to manufacture non-standard components</li> </ul>	
<b>1.5 Design for manufacturing and assembly (DFMA)</b>	
<b>1.5.1 Principles of DFMA</b>	
<ul style="list-style-type: none"> <li>□ Influence of manufacturing process on component design <ul style="list-style-type: none"> <li>• Design for casting</li> <li>• Design for machining</li> <li>• Design for sheet metal and fabrication</li> <li>• Design for injection moulding</li> <li>• Design for assembly</li> </ul> </li> </ul>	
<b>1.5.2 Identification of design features that aid manufacture and assembly</b>	
<ul style="list-style-type: none"> <li>□ Features that aid component manufacture: <ul style="list-style-type: none"> <li>• Draft angles</li> <li>• Additional hanging holes (for powder coating)</li> <li>• No over-processing to achieve unnecessary surface finishes or tolerances</li> </ul> </li> <li>□ Features that aid assembly: <ul style="list-style-type: none"> <li>• Design simplification</li> <li>• Minimising the number of components</li> <li>• Use of common fixings</li> <li>• Build in fasteners and clip together assemblies</li> <li>• Self-aligning assemblies</li> <li>• Asymmetric fixing holes</li> <li>• Use of self-tapping screws</li> <li>• Locating holes, slots, pins</li> <li>• Male/female mating parts</li> <li>• Interference fits</li> <li>• Clearances and accessibility</li> </ul> </li> </ul>	

<b>Topic Area 2: Product redesign</b>	
<b>Teaching content</b>	<b>Exemplification</b>
<b>2.1 Product redesign</b>	
<b>2.1.1 Factors driving product redesign</b>	
<ul style="list-style-type: none"> <li>□ <b>Functionality</b> <ul style="list-style-type: none"> <li>• Introduction of new features/functionality</li> <li>• Performance</li> <li>• Ergonomics</li> <li>• Portability</li> <li>• Toughness</li> <li>• Weight</li> <li>• Safety</li> <li>• Waterproofness</li> <li>• Corrosion resistance</li> </ul> </li> <li>□ <b>Manufacturing</b> <ul style="list-style-type: none"> <li>• Ease of manufacture</li> <li>• Ease of assembly</li> <li>• Material cost</li> <li>• Scale of production</li> </ul> </li> <li>□ <b>Sustainability</b> <ul style="list-style-type: none"> <li>• Serviceability/ease of maintenance and repair</li> <li>• Service life</li> <li>• Reusability</li> <li>• Recyclability</li> <li>• Efficiency</li> <li>• Material usage</li> <li>• Environmental impact</li> </ul> </li> <li>□ <b>Product appeal</b> <ul style="list-style-type: none"> <li>• Inclusivity</li> <li>• Exclusivity</li> <li>• Aesthetics</li> <li>• Quality</li> <li>• Cost</li> </ul> </li> </ul>	
<b>2.1.2 Stages of the design process:</b>	
<ul style="list-style-type: none"> <li>□ <b>Design brief</b> <ul style="list-style-type: none"> <li>• Interpreting a design brief</li> </ul> </li> <li>□ <b>Analysis and research</b> <ul style="list-style-type: none"> <li>• Information from product analysis</li> <li>• Research design of other existing products</li> <li>• Research materials and processes used in existing products</li> </ul> </li> <li>□ <b>Ideate</b> <ul style="list-style-type: none"> <li>• Creative approaches to ideation               <ul style="list-style-type: none"> <li>○ Thumbnail sketches</li> <li>○ Spider diagrams/mind maps</li> </ul> </li> </ul> </li> </ul>	

<ul style="list-style-type: none"> <li>□ Develop <ul style="list-style-type: none"> <li>• Selection and development of a final design proposal</li> <li>• Selection of materials and manufacturing processes</li> </ul> </li> <li>□ Realise <ul style="list-style-type: none"> <li>• Graphical presentation of a final design solution</li> </ul> </li> <li>□ Evaluate <ul style="list-style-type: none"> <li>• Evaluation of the design proposal against the design brief</li> </ul> </li> <li>□ Improve <ul style="list-style-type: none"> <li>• Identification of areas for improvement</li> </ul> </li> </ul>	
<p><b>2.1.3 Material and process selection</b></p> <ul style="list-style-type: none"> <li>□ Sources of information <ul style="list-style-type: none"> <li>• Material selection charts</li> <li>• Material databases</li> </ul> </li> <li>□ Determine material qualities to meet the needs of the product redesign <ul style="list-style-type: none"> <li>• Physical properties</li> <li>• Mechanical properties</li> <li>• Other material characteristics</li> <li>• Compatibility with manufacturing processes</li> </ul> </li> <li>□ Determine manufacturing process characteristics to meet the needs of the product redesign <ul style="list-style-type: none"> <li>• Compatibility with materials</li> <li>• Finish</li> <li>• Dimensional accuracy</li> <li>• Design For Manufacture and Assembly (DFMA) design requirements</li> </ul> </li> </ul>	
<p><b>2.2 Graphical presentation and communication of design solutions</b></p>	
<p><b>2.2.1 Application of freehand graphical techniques to create thumbnail sketches to communicate design ideas</b></p> <ul style="list-style-type: none"> <li>□ 2D and 3D sketches <ul style="list-style-type: none"> <li>• Using pens, pencils and markers</li> <li>• Isometric views</li> <li>• Notes, labels and annotation</li> </ul> </li> </ul>	
<p><b>2.2.2 Application of graphical techniques to create presentation drawings to visualise design solutions</b></p> <ul style="list-style-type: none"> <li>□ 3D presentation drawings <ul style="list-style-type: none"> <li>• Using pens, pencils and markers</li> <li>• Using drawing aids</li> <li>• Isometric views</li> <li>• Perspective views</li> </ul> </li> </ul>	<p>Does not include: Use of CAD or other graphics software</p>

<ul style="list-style-type: none"> <li>• 'Thick and thin line' technique</li> <li>• Rendering to show light source, shading, colour and surface texture</li> <li>• Layout and presentation</li> <li>• Notes, labels and annotation</li> </ul>	
---	--

### Assessment criteria

**Section 6.4** provides full information on how to assess the NEA units and apply the assessment criteria.

These are the assessment criteria for the tasks for this unit. The assessment criteria indicate what is required in each task. Students' work must show that all aspects of a criterion have been met in sufficient detail for it to be **successfully achieved** (see **Section 6.4.1**). If a student's work does not fully meet a criterion, you must not award that criterion.

The command words used in the assessment criteria are defined in **Appendix B**.

Pass	Merit	Distinction
<b>P1: Describe</b> the function(s) of the product.	<b>M1: Explain</b> how the operating principles enable the product to function.	
<b>P2: Safely disassemble</b> an engineered product into its main components.	<b>M2: Produce</b> information about how to methodically disassemble the product.	<b>D1: Produce</b> clear guidance to allow reassembly of the product by a third party.
<b>P3: Identify</b> the materials used to make <b>two</b> different non-standard components.		<b>D2: Analyse</b> the materials and processes used for <b>two</b> non-standard components, including how you were able to identify them.
<b>P4: Identify two DFMA related</b> design features from the components in <b>P3</b> .		
<b>P5: Identify</b> suitable manufacturing processes used to make <b>two</b> different non-standard components.		
<b>P6: Summarise</b> research into similar existing products.		
<b>P7: Create three</b> different design ideas for each of the requirements of the design brief, using annotated freehand sketches.	<b>M3: Analyse</b> how effectively the different design ideas fulfil the requirements of the design brief.	<b>D3: Justify</b> the selection of one idea for each requirement for further development.
<b>P8: Draw</b> detailed annotated freehand sketches to communicate the development of a final design that meets the requirements of the design brief.		
<b>P9: Draw</b> a 3D presentation line drawing of the final design from <b>P8</b> .	<b>M4: Use</b> rendering, colour, appropriate labelling and annotation to enhance the 3D presentation drawing of the final design ( <b>P9</b> ).	



Pass	Merit	Distinction
<b>P10: Select two</b> different, appropriate materials for use in the manufacture of the product.	<b>M5: Justify</b> the selection of <b>two</b> materials in terms of their qualities, for use in the manufacture of the product.	
<b>P11: Select two</b> different, appropriate processes for the manufacture of the product.		<b>D4: Justify</b> the selection of the <b>two</b> processes in terms of their characteristics, for use in the manufacture of the product.
	<b>M6: Analyse</b> how effectively the final design fulfils the requirements of the design brief.	<b>D5: Recommend</b> further appropriate improvements to the final design.

### Assessment guidance

This assessment guidance gives you information relating to the assessment criteria. There might not be additional assessment guidance for each assessment criterion. It is included only where it is needed.

Assessment Criteria	Assessment guidance
P2	<ul style="list-style-type: none"> <li>Permanent fixings do not need to be taken apart as part of any disassembly. You also do not need to disassemble any of the electrical or electronic components.</li> <li>Guidance on the main components will be given in the advice section of each assignment.</li> </ul>
P3	<ul style="list-style-type: none"> <li>The non-standard components selected need to be made using different materials and different processes.</li> </ul>
P4	
P5	
D2	<ul style="list-style-type: none"> <li>Students must consider the design requirements.</li> </ul>
P7	<ul style="list-style-type: none"> <li>The emphasis here is on creating different design ideas rather than drawing skills although drawings need to be of sufficient quality to communicate the ideas effectively.</li> <li>Students can produce three product designs, each of which has different ideas for each of the requirements, or they can produce separate ideas for each of the requirements (for example, three sets of three thumbnails per requirement).</li> <li>The different design ideas should have different forms.</li> </ul>
M3	
P8	<ul style="list-style-type: none"> <li>The emphasis here is on the quality of the drawings and communication of the final design idea as well as the suitability of the final design.</li> </ul>
P9	<ul style="list-style-type: none"> <li>The emphasis here is on drawing skills and communication skills rather than the quality of the final design or its suitability to meet the requirements from the brief.</li> </ul>
M4	
P10	<ul style="list-style-type: none"> <li>Students must include notes to indicate the selection and use of <b>two</b> different materials.</li> </ul>
P11	<ul style="list-style-type: none"> <li>Students must include notes to indicate the selection and use of <b>two</b> different processes.</li> </ul>
M6	<ul style="list-style-type: none"> <li>The qualities refers to those listed in the unit under section 2.1.3 Material and process selection.</li> </ul>
D4	<ul style="list-style-type: none"> <li>The characteristics refers to those listed in the unit under section 2.1.3 Material and process selection.</li> </ul>

## Synoptic assessment

Some of the knowledge, understanding and skills required when completing this unit will draw on the learning developed in unit F131, Materials science and technology.

The following table details where these synoptic links can be found:

Unit F135: Mechanical product design		Unit F131: Materials science and technology	
Topic Area		Topic Area	
1	Product analysis	3	Effect of processing techniques on material properties
		2	Types of material
2	Product redesign	1	Material properties

More information about synoptic assessment in these qualifications can be found in **Section 5.2 Synoptic assessment**.

DRAFT

### 4.3.5 Unit F136: Computer Aided Manufacture (CAM)

#### Essential resources required for this unit:

- CAD Software
- CNC programming software (this may be integrated within the CAD software)
- CNC controlled machines
  - Subtractive – e.g. CNC milling machine **or** CNC lathe as a minimum requirement
  - Additive – e.g. 3D printer as a minimum requirement

#### Unit Aim

Companies that manufacture products are often reliant on computer systems to direct the manufacturing processes. This is known as Computer Aided Manufacturing (CAM). CAM is used extensively in manufacturing, helping to create products with a higher degree of speed, accuracy and consistency than would otherwise be possible.

In this unit you will learn how CAM systems are used in manufacturing. You will develop the skills to be able to program and use Computer Numerical Control (CNC) machines to produce components and to use CAD/CAM to manufacture a component. Finally, you will learn how to evaluate a component against a working drawing.

Unit F136: Computer Aided Manufacture (CAM)	
Topic Area 1: Subtractive and additive Computer Aided Manufacturing (CAM) processes	
Teaching content	Exemplification
<b>1.1 Commercial subtractive manufacturing processes</b>	
Subtractive manufacturing process: <ul style="list-style-type: none"> <li>□ CNC milling and CNC turning</li> <li>□ Key parts/features of the CAM machines</li> <li>□ Operations and materials the machines can be used for</li> <li>□ Tool types</li> <li>□ Sustainability considerations</li> <li>□ Manufacturing volumes               <ul style="list-style-type: none"> <li>• One off</li> <li>• Batch</li> <li>• Mass</li> </ul> </li> </ul>	To include: <ul style="list-style-type: none"> <li>□ Number of axis 3, 4, or 5</li> <li>□ Metal and polymer materials</li> <li>□ Advantages and disadvantages of subtractive manufacturing processes               <ul style="list-style-type: none"> <li>• Advantages                   <ul style="list-style-type: none"> <li>○ Wide selection of end-use materials</li> <li>○ Good dimensional control and surface finish</li> <li>○ High degree of repeatability suitable for end-use manufacture</li> </ul> </li> <li>• Disadvantages                   <ul style="list-style-type: none"> <li>○ Material waste</li> <li>○ Geometry limitations</li> </ul> </li> </ul> </li> </ul> Examples of <b>machining operations</b> may include: <ul style="list-style-type: none"> <li>□ Boring</li> <li>□ Facing</li> <li>□ Grooving</li> <li>□ Thread cutting</li> <li>□ Slots</li> <li>□ Contouring</li> <li>□ Flat-bottomed cavities/pockets</li> </ul>

	<p>Examples of <b>tool types</b> may include:</p> <ul style="list-style-type: none"> <li>□ Turning</li> <li>□ Boring</li> <li>□ Facing</li> <li>□ Chamfering</li> <li>□ Knurling</li> <li>□ Parting</li> </ul> <p>Examples of <b>sustainability considerations</b> may include:</p> <ul style="list-style-type: none"> <li>□ Disposal of swarf</li> <li>□ Cutting fluids and cutting tools</li> <li>□ The amount of energy required</li> </ul>
<b>1.2 Commercial additive manufacturing processes</b>	
<p>Additive manufacturing (AM) processes:</p> <ul style="list-style-type: none"> <li>□ Types of AM process.</li> <li>□ Key parts/features of the machines</li> <li>□ Operations and materials the machines can be used for.</li> <li>□ Sustainability considerations</li> <li>□ Finishing processes</li> <li>□ Manufacturing volumes <ul style="list-style-type: none"> <li>• One off</li> <li>• Batch</li> <li>• Mass</li> </ul> </li> </ul>	<p>To include:</p> <ul style="list-style-type: none"> <li>□ Key parts/features of the machines</li> <li>□ Suitable materials, metals and polymers</li> <li>□ Operations including geometric complexity, surface texture, and tolerances</li> <li>□ Machine capacity including machine size and manufacturing throughput speed</li> <li>□ Advantages and disadvantages of additive manufacturing processes <ul style="list-style-type: none"> <li>• Advantages: <ul style="list-style-type: none"> <li>○ Rare shape manufacture</li> <li>○ Manufacture and assembly as single operation</li> <li>○ Reduced tooling costs</li> </ul> </li> <li>• Disadvantages: <ul style="list-style-type: none"> <li>○ High part costs especially for metal additive processes</li> <li>○ Slow</li> <li>○ Size limitations</li> </ul> </li> </ul> </li> </ul> <p>Examples of <b>AM processes</b> may include:</p> <ul style="list-style-type: none"> <li>□ Material extrusion – fused deposition modelling (FDM)</li> <li>□ Powder bed fusion – electron beam melting, laser powder bed/sintering</li> <li>□ Photo polymerization – Selective Laser Sintering (SLS), stereolithography (SLA), Digital Light Processing (DLP)</li> <li>□ Material jetting – binder jetting</li> </ul>

	<p>Examples of <b>sustainability considerations</b> may include:</p> <ul style="list-style-type: none"> <li>□ Powder bed fusion process allows recycling of unused metallic powder and polymer-based materials</li> <li>□ There is limited waste material produced</li> <li>□ The amount of energy required</li> <li>□ Local manufacturing at the point of consumption reduces the need for transportation</li> <li>□ Lower mass/less material is required due to topology optimization approaches</li> </ul> <p>Examples of <b>finishing processes</b> to remove the aliasing/stepping may include:</p> <ul style="list-style-type: none"> <li>□ Shot blasting</li> <li>□ Vibro-energy grinding</li> <li>□ Chemical processes</li> <li>□ Hot isostatic processing (HIPping)</li> <li>□ Machining</li> </ul>
<p><b>Topic Area 2: Three dimensional (3D) Computer Aided Design (CAD) modelling of prototype components</b></p>	
<p><b>Teaching content</b></p>	<p><b>Exemplification</b></p>
<p><b>2.1. Producing 3D CAD models</b></p>	
<ul style="list-style-type: none"> <li>□ Modelling a component using a 3D CAD software package</li> </ul>	<p>To include:</p> <ul style="list-style-type: none"> <li>□ Sketching geometries</li> <li>□ Use of functional dimensions</li> </ul> <p>Examples of 3D CAD commands may include:</p> <ul style="list-style-type: none"> <li>□ Extrude</li> <li>□ Rotate</li> <li>□ Holes and threads</li> <li>□ Fillets</li> <li>□ Resizing</li> </ul>
<p><b>2.2. The design of components for subtractive and additive manufacturing processes</b></p>	
<ul style="list-style-type: none"> <li>□ Design for subtractive manufacturing (DFSM)</li> <li>□ Design for additive manufacturing (DFAM)</li> </ul>	<p>Examples of adapting a component's <b>design for subtractive</b> processes may include:</p> <ul style="list-style-type: none"> <li>□ Internal corners must have radii.</li> <li>□ Holes cannot have curved geometries.</li> <li>□ Wall thicknesses cannot be too thin</li> <li>□ Small diameter holes and deep cavities cannot easily be produced</li> <li>□ Suitable thread profiles</li> </ul>

	<p>Examples of adapting a component's <b>design for additive manufacturing</b> processes may include:</p> <ul style="list-style-type: none"> <li>□ Reduced mass from applying approaches related to topology optimisation and the inclusion of hollow sections</li> <li>□ Integration of parts and completed assemblies</li> <li>□ Support structures</li> <li>□ Surface finish considerations aliasing/stepping</li> <li>□ The creation of edges</li> <li>□ Suitable thread profiles</li> <li>□ Distortion including warping and shrinkage</li> </ul>
<b>Topic Area 3: Manufacturing prototype components using subtractive processes</b>	
<b>Teaching content</b>	<b>Exemplification</b>
<b>3.1 Produce a CNC program</b>	
<ul style="list-style-type: none"> <li>□ Part programming for CNC machines</li> <li>□ Tooling</li> <li>□ Simulating and editing a part program</li> <li>□ Analysis using CAM software</li> <li>□ Import and export files</li> </ul>	<p>To include:</p> <ul style="list-style-type: none"> <li>□ Simulating a part program: <ul style="list-style-type: none"> <li>• to visualise production sequences</li> <li>• to check tool cutter paths and operations</li> <li>• for logical and syntax errors</li> <li>• to improve the efficiency of the manufacturing process</li> </ul> </li> <li>□ Editing a CNC part program involving: <ul style="list-style-type: none"> <li>• G and M codes</li> <li>• Co-ordinates: X, Y, Z coordinates, absolute, incremental</li> <li>• Positions</li> <li>• Directions</li> <li>• Tool types and selection</li> <li>• Speed and feed rates</li> <li>• Tool changing/qualified tooling</li> </ul> </li> <li>□ Adjustment of machine settings through the manipulation of manual programming techniques and program code</li> <li>□ Cutter compensation</li> <li>□ CAM software to export and import data in appropriate formats including IGES, DXF, STL</li> <li>□ CAM software analysis to include: <ul style="list-style-type: none"> <li>• Positioning</li> <li>• Machining operations</li> <li>• Tooling selection and tool changing</li> <li>• Simulating cutting paths</li> <li>• Review and improve the CNC program</li> </ul> </li> </ul> <p>Examples of <b>CNC machines</b> may include:</p> <ul style="list-style-type: none"> <li>□ CNC milling machine</li> <li>□ CNC turning machine</li> </ul>

<b>3.2 Using CNC machines to produce components</b>	
<p><b>3.2.1 CNC Machine set-up</b></p> <ul style="list-style-type: none"> <li>□ Production planning <ul style="list-style-type: none"> <li>• Materials</li> <li>• Tools</li> <li>• Jigs/fixtures/clamps</li> <li>• Operations</li> <li>• Sequence of operations</li> </ul> </li> <li>□ Subtractive manufacturing machine set-up: <ul style="list-style-type: none"> <li>• Tools</li> <li>• Datums</li> <li>• Jigs/fixtures</li> <li>• Clamps</li> <li>• Setting tooling</li> <li>• Data/file transfer</li> </ul> </li> <li>□ Safe working practices</li> </ul>	<p>To include:</p> <ul style="list-style-type: none"> <li>□ How to import data/files into CNC machines</li> <li>□ Datums: machine and program</li> </ul> <p>Examples of <b>Subtractive manufacturing machines</b> may include:</p> <ul style="list-style-type: none"> <li>□ CNC milling</li> <li>□ CNC turning machines</li> </ul> <p>Examples of <b>tools</b> may include:</p> <ul style="list-style-type: none"> <li>□ Drills</li> <li>□ Tooling inserts</li> <li>□ Reamers</li> <li>□ End/face mill</li> <li>□ Thread mill</li> </ul> <p>Examples of <b>safe working practices</b> may include:</p> <ul style="list-style-type: none"> <li>□ Use of Personal Protective Equipment (PPE)</li> <li>□ Use of machine guards and interlocks</li> <li>□ Appropriate use of coolant</li> </ul>
<p><b>3.2.2 Operate a CNC machine</b></p> <ul style="list-style-type: none"> <li>□ Checking and further simulation on the machine control unit (MCU).</li> <li>□ Machining and roughing and finishing operations</li> <li>□ Tool changing</li> <li>□ Coolant flow</li> <li>□ Inspection of the physical part.</li> <li>□ Safe working practices</li> </ul>	<p>Examples of <b>checking and further simulation</b> may include:</p> <ul style="list-style-type: none"> <li>□ Dry runs</li> <li>□ Step through</li> <li>□ Setting</li> <li>□ First off checks</li> </ul> <p>Examples of <b>operations</b> may include:</p> <ul style="list-style-type: none"> <li>□ Irregular geometry</li> <li>□ Pockets</li> <li>□ Threads</li> <li>□ Roughing and finishing: <ul style="list-style-type: none"> <li>• Cycle time</li> <li>• Canned cycle</li> <li>• Macros</li> </ul> </li> </ul> <p>Examples of <b>inspection of the physical part</b> may include:</p> <ul style="list-style-type: none"> <li>□ Measurement tools for example vernier callipers, steel rule and micrometres</li> <li>□ Dimensional comparison with the engineering drawings and, if needed, editing the program/tool settings</li> </ul>

	<p>Examples of <b>safe working practices</b> may include:</p> <ul style="list-style-type: none"> <li><input type="checkbox"/> Use of Personal Protective Equipment (PPE)</li> <li><input type="checkbox"/> Use of machine guards and interlocks</li> <li><input type="checkbox"/> Appropriate use of coolant</li> <li><input type="checkbox"/> Feed and speed overrides</li> <li><input type="checkbox"/> Machine shutdown</li> </ul>
<b>Topic Area 4: Manufacturing prototype components using additive processes</b>	
<b>Teaching content</b>	<b>Exemplification</b>
<b>4.1 Plan, set-up and operate an additive manufacturing machine to produce a component</b>	
<ul style="list-style-type: none"> <li><input type="checkbox"/> Production planning <ul style="list-style-type: none"> <li>• Materials</li> <li>• Tools</li> <li>• Component's orientation</li> <li>• Support structure(s)</li> <li>• Machine set-up and settings</li> <li>• Finishing operations</li> </ul> </li> <li><input type="checkbox"/> Additive manufacturing machine set up</li> <li><input type="checkbox"/> Additive manufacturing machine settings</li> <li><input type="checkbox"/> Manufacturing operation and sustainability</li> <li><input type="checkbox"/> Safe working practices</li> <li><input type="checkbox"/> Finishing operations</li> <li><input type="checkbox"/> Inspection of the physical part</li> </ul>	<p>Examples of <b>machine set-up and settings</b> in production planning may include:</p> <ul style="list-style-type: none"> <li><input type="checkbox"/> Conversion from STL file to G-code/slicing software</li> <li><input type="checkbox"/> Simulations</li> </ul> <p>Examples of <b>additive manufacturing machine set up</b> may include:</p> <ul style="list-style-type: none"> <li><input type="checkbox"/> Setting datums</li> <li><input type="checkbox"/> Component orientation and scale on the print bed</li> <li><input type="checkbox"/> Loading filaments and binders</li> <li><input type="checkbox"/> Data transfer <ul style="list-style-type: none"> <li>• Wi-Fi</li> <li>• Direct link</li> <li>• SD card</li> </ul> </li> </ul> <p>Examples of <b>additive machine settings</b> may include:</p> <ul style="list-style-type: none"> <li><input type="checkbox"/> Infill</li> <li><input type="checkbox"/> Layer height</li> <li><input type="checkbox"/> Feed rate</li> <li><input type="checkbox"/> Travel feed rate</li> <li><input type="checkbox"/> Temperature</li> <li><input type="checkbox"/> Resolution</li> </ul> <p>Examples of <b>manufacturing operation and sustainability</b> may include:</p> <ul style="list-style-type: none"> <li><input type="checkbox"/> Starting the process</li> <li><input type="checkbox"/> Removal of the finished component and cleaning the machine down</li> <li><input type="checkbox"/> Recycling waste material</li> <li><input type="checkbox"/> Machine shut down</li> </ul>



	<p>Examples of <b>safe working practices</b> may include:</p> <ul style="list-style-type: none"> <li>□ Use of personal protective equipment (PPE)</li> <li>□ In place and secure machine guards</li> </ul> <p>Examples of <b>finishing operations</b> may include:</p> <ul style="list-style-type: none"> <li>□ Chemically rated</li> <li>□ Sanded</li> <li>□ Shot blasted</li> <li>□ Removal of support structures</li> </ul> <p>Examples of <b>inspection of the physical part</b> may include:</p> <ul style="list-style-type: none"> <li>□ Measurement tools <ul style="list-style-type: none"> <li>• Vernier callipers</li> <li>• Steel rule</li> <li>• Micrometres</li> </ul> </li> <li>□ Dimensional comparison with the engineering drawings and if required editing the program/tool settings</li> </ul>
<p><b>Topic Area 5: Evaluating prototype components manufactured using subtractive and additive manufacturing processes</b></p>	
<p><b>Teaching content</b></p>	<p><b>Exemplification</b></p>
<p><b>5.1 Evaluating components</b></p>	
<ul style="list-style-type: none"> <li>□ Tools</li> <li>□ Measuring physical components against a drawing including dimensions, tolerances, and accuracy</li> <li>□ Investigating the suitability of the subtractive and additive manufacturing processes to make the components</li> </ul>	<p>To include:</p> <ul style="list-style-type: none"> <li>□ Measurement tools for example vernier callipers, steel rule and micrometres</li> <li>□ Resolution – the smallest value of change the instrument can measure</li> <li>□ Measuring the physical components including: <ul style="list-style-type: none"> <li>• Dimension – the desired length of a feature of a component</li> <li>• Tolerance - the maximum allowed deviation</li> <li>• Accuracy - the deviation between the measured dimension and the specified dimension</li> </ul> </li> </ul> <p>Examples of ways to <b>investigate the suitability</b> of components may include:</p> <ul style="list-style-type: none"> <li>□ Surface finish</li> <li>□ Tolerances</li> <li>□ Materials</li> <li>□ Mass</li> <li>□ Appearance</li> </ul>

## Assessment criteria

**Section 6.4** provides full information on how to assess the NEA units and apply the assessment criteria.

These are the assessment criteria for the tasks for this unit. The assessment criteria indicate what is required in each task. Students' work must show that all aspects of a criterion have been met in sufficient detail for it to be **successfully achieved** (see **Section 6.4.1**). If a student's work does not fully meet a criterion, you must not award that criterion.

The command words used in the assessment criteria are defined in **Appendix B**.

Pass	Merit	Distinction
<p><b>P1: Describe</b> how the component can be manufactured using subtractive CAM processes.</p>	<p><b>M1: Explain</b> what sustainability considerations should be applied in the manufacture of the component using subtractive and additive CAM processes.</p>	<p><b>D1: Evaluate</b> the suitability of subtractive and additive CAM processes to manufacture the component.</p>
<p><b>P2: Describe</b> how the component can be manufactured using additive CAM processes.</p>		
<p><b>P3: Produce</b> an accurate 3D CAD model of the prototype component from the given engineering drawing.</p>	<p><b>M2: Adapt</b> the 3D CAD model showing appropriate consideration of DFAM.</p>	<p><b>D2: Justify</b> the DFAM and DFAM adaptations to the 3D CAD models of the prototype component.</p>
	<p><b>M3: Adapt</b> the 3D CAD model showing appropriate consideration of DFAM.</p>	
<p><b>P4: Produce</b> a production plan for the manufacture of the prototype component using a CNC subtractive process.</p>		
<p><b>P5: Import</b> the model and simulate the program.</p>	<p><b>M4: Interpret</b> simulation results and make appropriate improvements.</p>	
<p><b>P6: Operate</b> and shut down a CNC machine safely for the subtractive manufacture of the prototype component.</p>	<p><b>M5: Set up</b> a CNC machine safely, appropriately and independently.</p>	<p><b>D3: Justify</b> the machine settings used.</p>

Pass	Merit	Distinction
<b>P7: Produce</b> a production plan for the manufacture of the prototype component using an additive manufacturing process.		<b>D4: Justify</b> the machine settings used.
<b>P8: Manufacture</b> the prototype component safely using the additive manufacturing machine, including set up, operation and shut down.		
<b>P9: Complete</b> prototype component removal and finishing operations.		
<b>P10: Measure</b> accurately the functional dimensions of the two manufactured prototype components using appropriate measuring equipment.	<b>M6: Analyse</b> the effectiveness of DFSS and DFAM applied to manufacture the prototype components.	<b>D5: Recommend</b> improvements to the drawings and manufacturing processes for each component you manufactured.
<b>P11: Determine</b> whether the functional dimensions of each prototype component are within tolerance.		

### Assessment guidance

This assessment guidance gives you information relating to the assessment criteria. There might not be additional assessment guidance for each assessment criterion. It is included only where it is needed.

Assessment Criteria	Assessment guidance
P1	<ul style="list-style-type: none"> <li>Students must cover more than one subtractive process for commercial manufacture.</li> <li>Students could consider using images to support their descriptions of the processes.</li> </ul>
P2	<ul style="list-style-type: none"> <li>Students must cover more than one additive process for commercial manufacture.</li> <li>Students could consider using images to support their descriptions of the processes.</li> </ul>
D1	<ul style="list-style-type: none"> <li>Students must consider the advantages and disadvantages of subtractive and additive processes for the component chosen and the order volume. They need to make a recommendation about the best subtractive process to use and the best additive process to use.</li> </ul>

Assessment Criteria	Assessment guidance
P3	<ul style="list-style-type: none"> <li>Students need to produce an initial 3D model which reflects the engineering drawing given and retains the functional dimensions specified by the client.</li> </ul>
M2	<ul style="list-style-type: none"> <li>Students must adapt the 3D model from P3 to make it suitable for subtractive manufacturing with reference to Topic Area 2.2.</li> </ul>
M3	<ul style="list-style-type: none"> <li>Students must adapt the 3D model from P3 to make it suitable for subtractive manufacturing with reference to Topic Area 2.2.</li> </ul>
D2	<ul style="list-style-type: none"> <li>Students must give valid reasons for how the adaptations made in M2 and M3 make the design more suitable for each manufacturing process.</li> </ul>
P4	<ul style="list-style-type: none"> <li>The plan must reflect Topic Area 3.2.1.</li> </ul>
P5	<ul style="list-style-type: none"> <li>Students must be able to import and run the simulation to check for errors.</li> </ul>
M4	<ul style="list-style-type: none"> <li>Students must make suggestions for improvements to the program rather than the CAD model at this stage.</li> <li>Students could make notes about any potential improvements which could be made to the CAD model in readiness for Task 5.</li> <li>If there are no improvements to make based on the simulation results, students must explain these results to achieve M4 (rather than suggest unnecessary improvements)</li> <li>Teacher/technician support is allowed to ensure that a working model is available so that subsequent tasks and criteria can still be achieved. <b>Where this support is needed M4 cannot be awarded.</b></li> </ul>
P6	<ul style="list-style-type: none"> <li>Students can still achieve this criterion even if some support is needed from staff, as long as the student is able to operate and shut down the machine safely with support and/or guidance.</li> </ul>
M5	<ul style="list-style-type: none"> <li>Students must have been able to operate in a safe and appropriate way <b>independently</b> without any support or intervention from staff to achieve this.</li> </ul>
D3	<ul style="list-style-type: none"> <li>Students must give valid reasons for the machine settings used and why they were chosen.</li> <li>This criterion could be evidenced within the simulation results or as separate written notes with screen shots of the settings.</li> </ul>
P7	<ul style="list-style-type: none"> <li>The plan must reflect Topic Area 4.1.</li> <li>Production planning must include any simulation undertaken and alterations made in preparation for a successful additive manufacturing process.</li> </ul>
D4	<ul style="list-style-type: none"> <li>Students must give valid reasons for the machine settings used and why they were chosen.</li> <li>This criterion could be evidenced within the production plan, as separate written notes, or as part of the annotated photographs of the manufacturing process.</li> </ul>
P9	<ul style="list-style-type: none"> <li>Students must use relevant finishing operations for the additive process used to produce the final prototype.</li> </ul>
P10	<ul style="list-style-type: none"> <li>Equipment is 'appropriate' if it enables an accurate measurement to be taken for the product and dimension in question.</li> </ul>
P11	<ul style="list-style-type: none"> <li>If students measurements (P10) lack accuracy but the actual prototype is within tolerances P11 can be awarded based on the teachers measurements of the prototype.</li> <li>Conversely, P11 is <b>not</b> achieved if the students' measurements are within tolerances but the measurements are inaccurate.</li> </ul>

Assessment Criteria	Assessment guidance
M6	<ul style="list-style-type: none"> <li>Students need to analyse what worked well and where there were issues with their DFSM (M2) and DFAM (M3) adaptations (Task 2) in relation to the prototypes produced.</li> </ul>
D5	<ul style="list-style-type: none"> <li>For D5 students must make recommendations which cover both drawings and manufacturing processes.</li> <li>'Drawings' can be related back to the original 3D CAD model (P3), and/or to adaptations in M2 and M3.</li> <li>Manufacturing processes can include any aspects of the production planning or manufacture of the prototypes, including set up and settings.</li> </ul>

### Synoptic assessment

Some of the knowledge, understanding and skills required when completing this unit will draw on the learning developed in unit F130 Principles of engineering, and unit F131, Materials science and technology.

The following tables details where these synoptic links can be found:

F136: Computer Aided Manufacture (CAM)		F130: Principles of engineering	
Topic Area		Topic Area	
2	Three dimensional (3D) Computer Aided Design (CAD) modelling of prototype components	1	Mathematics
5	Evaluating prototype components manufactured using subtractive and additive manufacturing processes		

F136: Computer Aided Manufacture (CAM)		F131: Materials science and technology	
Topic Area		Topic Area	
1	Subtractive and additive Computer Aided Manufacturing (CAM) processes	2	Types of material
1	Subtractive and additive Computer Aided Manufacturing (CAM) processes	5	Sustainable materials in engineering
4	Manufacturing prototype components using additive processes		

More information about synoptic assessment in these qualifications can be found in **Section 5.2 Synoptic assessment**.

### 4.3.6 Unit F137: Electrical devices and circuits

#### Essential resources required for this unit:

- A range of electronic components and equipment

#### Unit Aim

Electronic devices heavily impact the way we live in the modern world. The emergence of semiconductor electronics paired with fundamental circuit theory has made it possible to develop low-cost and portable devices that have become an essential part of our daily lives including laptops, radios and mobile phones. Advances in technology and the miniaturisation of the transistor as a fundamental component means that they have an increasing number of applications and can be found in many household appliances such as washing machines, fridges, and microwaves.

In this unit, you will learn how to use circuit theory and fundamental electronics to design, build and test electronic circuits. You will develop the skills to build, test, analyse and evaluate Direct Current (DC) and Alternating Current (AC) circuits using the corresponding circuit theory. You will learn how to use semiconductor electronic circuits theory for a range of applications. Finally, you will learn how to use a range of hardware and software tools to analyse and evaluate circuit performance for given applications.

Unit F137: Electrical devices and circuits	
Topic Area 1: Power sources	
Teaching content	Exemplification
<b>1.1 Direct Current (DC) circuits</b>	
<b>1.1.1 Circuit analysis</b> <ul style="list-style-type: none"> <li>□ Voltage (<math>V</math>) and current (<math>I</math>) divider circuits configurations</li> <li>□ Kirchhoff's Current Law (KCL)</li> <li>□ Kirchhoff's Voltage Law (KVL)</li> <li>□ Simulation of circuits using Simulation Program with Integrated Circuit Emphasis (SPICE) software.</li> <li>□ Building physical circuits using breadboards or stripboard</li> <li>□ Measurement and test equipment</li> <li>□ Safe working practices</li> </ul>	<p>To include:</p> <ul style="list-style-type: none"> <li>□ Safe working practices when building and testing circuits</li> <li>□ Use of measurement and test equipment including DC power supply and multimeter</li> <li>□ Resistive (<math>R</math>) circuits only</li> <li>□ DC circuit theory: analyse DC circuits and apply Kirchhoff's laws</li> <li>□ Voltage divider circuits: apply the voltage divider rule to calculate voltage across a resistor as below or equivalent:</li> </ul> $V_{R1} = V_{IN} \times \frac{R_1}{R_1 + R_2}$ <ul style="list-style-type: none"> <li>□ Total resistance in a series combination of <math>N</math> resistors is:</li> </ul> $R_T = R_1 + R_2 + \dots R_N$ <ul style="list-style-type: none"> <li>□ Total current through the circuits is the supply voltage divided by the total resistance of the circuit:</li> </ul> $I_T = \frac{V}{R_T}$

- Verify that the voltage drop across a circuit is equal to the supply voltage

$$V_{IN} = V_{DROP}$$

- For a current divider circuits, apply the current divider rule to calculate the current through a resistor:
- Current through a resistor  $R_1$  will be:

$$I_{R1} = I_T \times \frac{R_2}{R_1 + R_2}$$

- Calculate the net resistance of the circuit by using the below equation or equivalent:

$$R_T = \frac{R_1 \times R_2}{R_1 + R_2}$$

- Prove that in a circuit with two nodes (Node 1 and Node 2) that has the currents flowing  $I_1$  and  $I_2$  and the supply current flowing  $I$  that the current through each node sums up to the supply or input current of the circuit as below:

$$I - I_1 - I_2 = 0$$

Does not include:

- Mesh analysis
- Nodal analysis
- Norton and Thevenin's theorems
- Inductive and capacitive circuits

## 1.2 Alternating Current (AC) circuits

- Phasor analysis:
  - Lead and lag of a waveform
  - $A(t) = A \sin(\omega t \pm \Phi)$
- Resistive-Inductive (RL), Resistive-Capacitive (RC) and Resistive Inductive and Capacitive (RLC) circuits
- A series RLC circuit with a resistor, an inductor, and a capacitor all in series
- A parallel RLC circuit with a resistor, an inductor, and a capacitor all in parallel
- Reactance ( $X$ ) and impedance ( $Z$ ) calculations
- Real, reactive and apparent power
- Power triangle
- Resonance and quality factor (Q-factor) in series and parallel RLC circuits
- Power factor and correction
- Measurement and test equipment
- Safe working practices

To include:

- Safe working practices when building and testing circuits
- Use of measurements and test devices including oscilloscope, signal generators and AC power supplies
- Graphical explanations of lead and lag phenomenon and calculate resultants using phasor relationships. Express using right-angled triangles that
  - In an RL circuit, voltage leads current by  $90^\circ$
  - In an RC circuit, current lead voltage by  $90^\circ$

This should then lead to resultant reactance as the difference of two reactance

- Phasor analysis in terms of phase angle between resistance and reactance including:
  - RL circuit
  - RC circuit
  - RLC circuit, when  $X_L > X_C$  and  $X_C > X_L$
- Calculations of:
  - Reactance and impedance

$$X_L = 2\pi fL$$

$$X_C = \frac{1}{2\pi fC}$$

$$Z_{LR} = (R + jX_L)$$

$$Z_{RC} = (R - jX_C)$$

$$Z = R + j(X_L - X_C)$$

- Equivalent polar representations where necessary as this will ensure calculations can be done easily and efficiently

- Use equations to convert from one form to another:

$$Z = R + jX = z \angle \theta^\circ$$

$$z = \sqrt{R^2 + X^2}$$

$$\theta = \tan^{-1} \left( \frac{X}{R} \right)$$

$$R = z \times \cos \theta$$

$$X = z \times \sin \theta$$



- Series current

$$I = \frac{V}{Z}$$

- Series voltages

$$V_L = IX_L$$

$$V_R = IR$$

$$V_C = IX_C$$

- Parallel currents

$$I_R = \frac{V}{R}$$

$$I_L = \frac{V}{X_L}$$

$$I_C = \frac{V}{X_C}$$

- In parallel configuration, voltage across each component will be the same as the supply voltage  $V$

- Using power triangle by applying trigonometric relationships

$$\text{Real Power } P = VI \cos\theta$$

$$\text{Reactive Power } Q = VI \sin\theta$$

$$\text{Apparent Power } S = VI$$

$$S^2 = P^2 + Q^2 \text{ or } S = \sqrt{P^2 + Q^2}$$

$$\text{Power Factor } P.F = \cos\theta$$

- Resonance

- The concept of resonance and calculation of resonant frequency  $f_0$
- Inductive and capacitive reactance change with frequency:

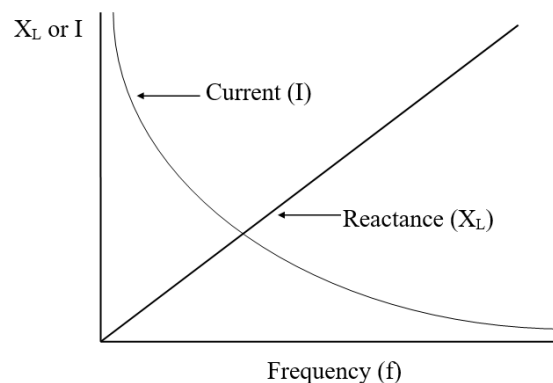

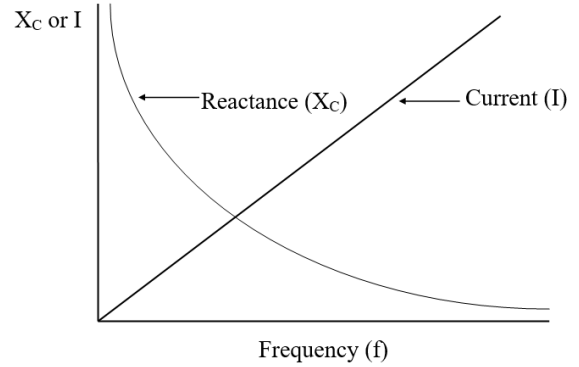

- $X_L > X_C$  which also means  $V_L > V_C$   
(as  $V_L = I \times X_L$  and  $V_C = I \times X_C$ )
- $X_C > X_L$  which also means  $V_C > V_L$
- $X_L = X_C$  which also means  $V_L = V_C$   
(this condition being called resonance)

- Be able to show that:

$$f_0 = \frac{1}{2\pi\sqrt{LC}}$$

- Be able to show that:

$$\omega_0 = 2\pi f_0$$

$$Q.F = \frac{\omega_0 L}{R} = \frac{2\pi f_0 L}{R} = \frac{1}{\omega_0 C R} = \frac{1}{2\pi f_0 C R}$$

$$\omega_{-3dB} = \frac{1}{RC}$$

$$B_{-3dB} = \frac{\omega_{-3dB}}{2\pi}$$

$$Q.F = \frac{\omega_0}{\omega_{-3dB}}$$

$$Q.F = \frac{f_0}{B_{-3dB}}$$

Does not include:

- Derived/complex of different harmonics such as sawtooth, triangular, square waves
- 3-phase

## Topic Area 2: Semiconductor devices

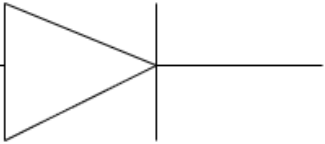
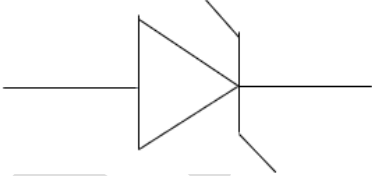
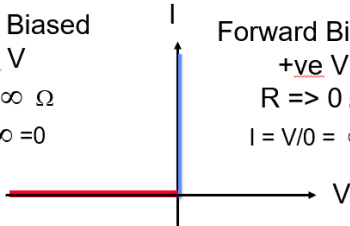
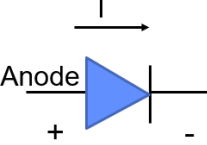
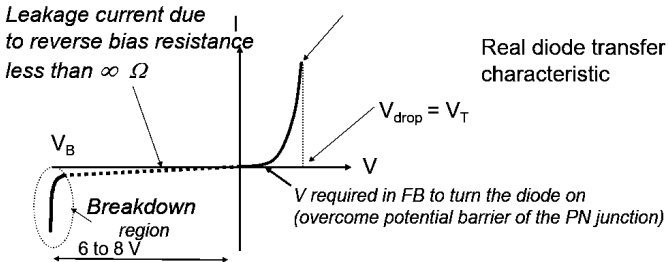
Teaching content	Exemplification
<b>2.1 Diodes and transistors</b>	
<p><b>2.1.1 Diode working principles and applications</b></p> <ul style="list-style-type: none"> <li>□ Forward and reverse biasing modes</li> <li>□ Types of diodes: <ul style="list-style-type: none"> <li>• Zener diode</li> <li>• Rectifier diode</li> </ul> </li> <li>□ Symbol and notation for a PN junction diode and the symbol for each type of diode</li> <li>□ Characteristics of diode with graphical representation including breakdown voltage</li> <li>□ Use of diodes for rectification and regulation</li> <li>□ Simulation of circuits using SPICE software</li> <li>□ Building physical circuits using breadboards or stripboard</li> <li>□ Measurement and test equipment</li> <li>□ Safe working practices</li> </ul>	<p>To include:</p> <ul style="list-style-type: none"> <li>□ Safe working practices when building and testing circuits</li> <li>□ Use of measurements and test devices including DC and AC power sources, signal generator and multimeter</li> <li>□ Forward and reverse biasing mode: <ul style="list-style-type: none"> <li>• Forward biased when: <math>V_{IN} &gt; V_{Threshold}</math></li> <li>• Reverse biased when: <math>V_{IN} &lt; V_{Threshold}</math></li> </ul> </li> <li>□ PN junction diode symbol and notation: <div style="text-align: center;">  </div> </li> <li>□ Rectifier diode symbol: <div style="text-align: center;">  </div> </li> <li>□ Zener diode symbol: <div style="text-align: center;">  </div> </li> <li>□ Ideal versus real diode characteristics</li> <li>□ Ideal diode acts as a: <ul style="list-style-type: none"> <li>▪ Short circuit (S/C) if voltage (anode to cathode) is positive (+ve)</li> <li>▪ Open circuit (O/C) if voltage (anode to cathode) is negative (-ve)</li> </ul> </li> </ul> <p>The transfer characteristic of an ideal diode is:</p> <div style="display: flex; align-items: center;"> <div style="margin-right: 20px;"> <p>Reverse Biased -ve V <math>R \Rightarrow \infty \Omega</math> <math>I = V/\infty = 0</math></p> </div> <div style="margin-right: 20px;">  </div> <div style="margin-right: 20px;"> <p>Forward Biased +ve V <math>R \Rightarrow 0 \Omega</math> <math>I = V/0 = \infty</math></p> </div> <div style="margin-right: 20px;">  </div> </div> <ul style="list-style-type: none"> <li>□ Real diode characteristics:</li> </ul> <div style="margin-top: 20px;"> <p><i>Leakage current due to reverse bias resistance less than <math>\infty \Omega</math></i></p> <p><i>Real diode transfer characteristic</i></p>  <p><math>V_B</math></p> <p><math>V_{drop} = V_T</math></p> <p><i>Breakdown region 6 to 8 V</i></p> <p><i>V required in FB to turn the diode on (overcome potential barrier of the PN junction)</i></p> </div>

- Diode's use for rectification and regulation
  - Half wave rectification:

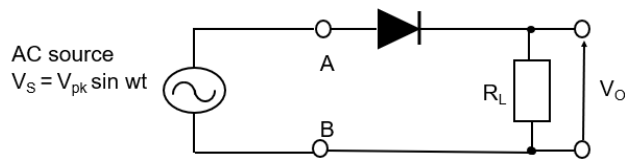

While  $V_S > V_T$  of the diode, the diode conducts and  $(V_S - V_T)$  appears across the load ( $V_O = V_S - V_T$ )

On the -ve half cycle the diode does not conduct, no current flows through the load and no voltage appears across it, since the reverse bias voltage is smaller than the voltage at B

$$V_O = 0V (V_S < V_T)$$

Smoothing effect of adding capacitor at the output

- Full wave rectification:

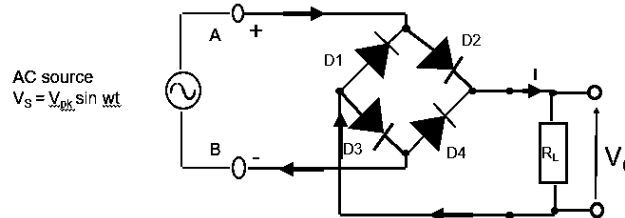

With terminal A +ve with respect to B :-

- $D2$  and  $D3$  are forward biased and so conduct, whereas
- $D1$  and  $D4$  are reverse bias, and so current passes in the direction of the arrows
- Current ( $I$ ) passes from terminal A to B through  $D2$ ,  $R_L$  and  $D3$

Does not include:

- Advanced applications such as voltage multipliers and spike suppressions

### 2.1.2 Transistors

- NPN formation
- PNP formation
- Representation of operating regions graphically:
  - Cut-off
  - Saturation
  - Active region
- Amplification and switching
- Biasing and configurations
- Measurement of open circuit voltages and short circuit current to illustrate the regions of operations

To include:

- Safe working practices when building and testing circuits
- Use of measurements and test devices including DC and AC power sources, signal generator and multimeter
- NPN and PNP transistors formation using two diodes:

#### NPN

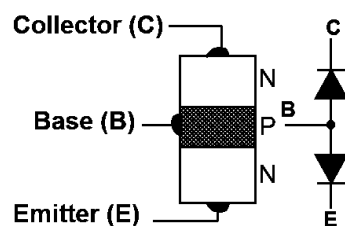

#### PNP

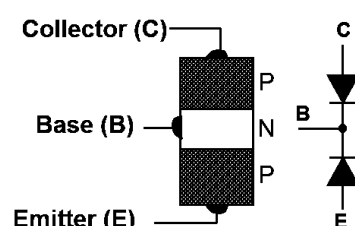

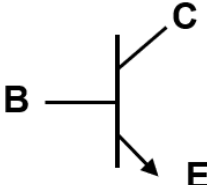
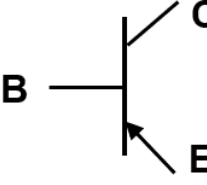
<ul style="list-style-type: none"> <li>□ Simulation of circuits using SPICE software</li> <li>□ Building physical circuits using breadboard or stripboard</li> <li>□ Measurement and test equipment</li> <li>□ Safe working practices</li> </ul>	<div style="display: flex; justify-content: space-around; align-items: center;"> <div style="text-align: center;">  <p><b>NPN Transistor</b></p> </div> <div style="text-align: center;">  <p><b>PNP Transistor</b></p> </div> </div> <ul style="list-style-type: none"> <li>□ Base is the input terminal, collector is the output terminal and emitter is the common terminal. For the transistors to function correctly</li> </ul> <p style="text-align: center;"><math>V_C &gt; V_B &gt; V_E</math></p> <p>The base-emitter (BE) junction must be forward-biased, and the base-collector (BC) must reverse-biased</p> <ul style="list-style-type: none"> <li>□ Function of an NPN transistor as a switch and amplifier. This will mean that transistor in cut-off and saturation regions acts as a switch and in active region acts as an amplifier</li> </ul> <p>Does not include:</p> <ul style="list-style-type: none"> <li>□ PNP transistors</li> <li>□ Multistage transistors</li> </ul>
--	--

**Topic Area 3: Analogue circuits**

Teaching content	Exemplification
------------------	-----------------

**3.1 Transistor based circuits**

<ul style="list-style-type: none"> <li>□ Bipolar Junction Transistor (BJT) amplifier circuits</li> <li>□ BJT Single stage common emitter (CE) amplifier circuits</li> <li>□ Class A, B, AB and C amplifiers</li> <li>□ Simulation of circuits using SPICE software.</li> <li>□ Building physical circuits using breadboards or stripboard</li> <li>□ Measurement and test equipment</li> <li>□ Safe working practices</li> </ul>	<p>To include:</p> <ul style="list-style-type: none"> <li>□ Safe working practices when building and testing circuits</li> <li>□ Use of measurements and test devices including DC and AC power sources, signal generator and multimeter</li> <li>□ BJT Amplifier <ul style="list-style-type: none"> <li>• Design of an audio amplifier i.e., a single stage common emitter amplifier</li> <li>• Current through the emitter is sum of the current through collector and the base</li> </ul> </li> </ul> $I_E = I_C + I_B$ <ul style="list-style-type: none"> <li>• The DC gain <math>\beta</math> of the transistor is: <math display="block">\beta = \frac{I_C}{I_B}</math> <math display="block">I_C = \beta \times I_B</math> </li> </ul> <ul style="list-style-type: none"> <li>□ DC analysis of NPN common emitter amplifier to be considered. Calculation of <math>I_B</math>, <math>I_C</math>, <math>I_E</math>, <math>V_{BE}</math>, <math>V_{CB}</math> and <math>V_{CE}</math> to be considered</li> <li>□ Above values are to be calculated using relevant equations for a common emitter amplifier</li> </ul> <p>Does not include:</p> <ul style="list-style-type: none"> <li>□ Multistage circuits</li> <li>□ Emitter follower circuits</li> </ul>
--	---

Topic Area 4: Digital circuits	
Teaching content	Exemplification
<b>4.1 Combinational logic</b>	
<b>4.1.1 Combinational circuits</b> <ul style="list-style-type: none"> <li>□ Boolean identities for 'and', 'or' and 'not' functions</li> <li>□ Boolean Laws: <ul style="list-style-type: none"> <li>• Commutative</li> <li>• Distributive</li> <li>• Associative</li> <li>• Absorption</li> <li>• Demorgan's law</li> </ul> </li> <li>□ Digital circuit representation using Truth Tables, circuit diagram and Boolean expression</li> <li>□ Circuits simplifications using Boolean laws and identities</li> <li>□ Combinational logic circuit design</li> <li>□ Simulation of circuits using SPICE software</li> <li>□ Building physical circuits using breadboards or stripboard</li> <li>□ Measurement and test equipment</li> <li>□ Safe working practices</li> </ul>	<p>To include:</p> <ul style="list-style-type: none"> <li>□ Safe working practices when building and testing circuits</li> <li>□ Use of measurements and test devices including power supplies and multimeters</li> <li>□ Examples of Boolean identities may include: <ul style="list-style-type: none"> <li>• And function - <math>0.1 = 0, 1.1 = 1, A.A = A</math></li> <li>• Or function - <math>0 + 0 = 0, A + 0 = A, A + 1 = 1</math></li> <li>• Not function - <math>0' = 1, (A')' = A</math></li> </ul> </li> <li>□ Examples of Boolean Laws may include: <ul style="list-style-type: none"> <li>• Commutative law: <math>A.B = B.A</math> <math>A + B = B + A</math></li> <li>• Distributive law: <math>A.(B + C) = A.B + AC</math> <math>A + B.C = (A + B).(A + C)</math></li> <li>• Demorgan's Law: <math>(A + B)' = A'.B'</math> <math>(AB)' = A' + B'</math></li> </ul> </li> <li>□ Circuit representation using truth table, Boolean expressions and the circuit diagram. All three forms to be presented. Sums of product to be identified for each of the circuit using the truth table</li> <li>□ Examples of design for <b>combinational circuits</b> may include: <ul style="list-style-type: none"> <li>• Half adder</li> <li>• Full adder</li> <li>• Multiplexers</li> <li>• Decoders</li> </ul> </li> </ul> <p>Does not include:</p> <ul style="list-style-type: none"> <li>□ NAND and NOR gate implementations of the circuits</li> <li>□ Karnaugh maps simplification</li> </ul>
<b>4.2 Sequential logic</b>	
<b>4.2.1 Sequential circuits</b> <ul style="list-style-type: none"> <li>□ Flip-flops <ul style="list-style-type: none"> <li>• Synchronous</li> <li>• Asynchronous</li> </ul> </li> <li>□ Transition table</li> <li>□ Sequential circuits design using different types of flip-flops</li> <li>□ Simulation of circuits using SPICE software</li> <li>□ Building physical circuits using breadboards or stripboard</li> <li>□ Measurement and test equipment</li> </ul>	<p>To include:</p> <ul style="list-style-type: none"> <li>□ Safe working practices when building and testing circuits</li> <li>□ Use of measurements and test devices including power supplies and multimeters.</li> <li>□ Flip-flops <ul style="list-style-type: none"> <li>• S-R flip-flops</li> <li>• J-K flip-flops</li> <li>• D flip-flops</li> <li>• Level and edge triggered</li> <li>• Synchronous and asynchronous: <ul style="list-style-type: none"> <li>○ In synchronous flip-flops, the state of a flip-flop is switched by a momentary change in input clock signal, a trigger</li> <li>○ Asynchronous flip-flops are triggered by the signal level (a change in the input will have an immediate effect on the output)</li> </ul> </li> </ul> </li> </ul>

<ul style="list-style-type: none"> <li>□ Safe working practices</li> </ul>	<ul style="list-style-type: none"> <li>□ Transition table to show the present and the next state of the sequential circuit.</li> <li>□ Examples of design for sequential circuits may include counter and registers</li> </ul> <p>Does not include:</p> <ul style="list-style-type: none"> <li>□ Debouncing circuits</li> </ul>
--	---

### Assessment criteria

**Section 6.4** provides full information on how to assess the NEA units and apply the assessment criteria.

These are the assessment criteria for the tasks for this unit. The assessment criteria indicate what is required in each task. Students' work must show that all aspects of a criterion have been met in sufficient detail for it to be **successfully achieved** (see **Section 6.4.1**). If a student's work does not fully meet a criterion, you must not award that criterion.

The command words used in the assessment criteria are defined in **Appendix B**.

Pass	Merit	Distinction
<b>P1: Simulate two</b> DC circuits, measuring the required currents, voltages and resistances.	<b>M1: Compare</b> the results from the simulated DC circuits and the physical DC circuits, giving reasons for any differences.	
<b>P2: Build two</b> physical DC circuits, measuring the required currents, voltages and resistances safely.		
<b>P3: Calculate</b> reactance, impedance, phase angle, current, voltage, power in a circuit with two or three passive RLC components in series or parallel configuration.	<b>M2: Produce</b> the resultant waveform graphically by the addition or subtraction of two sinusoidal waves with the same frequency.	<b>D1: Evaluate</b> the advantages of using power factor correction in a circuit.
<b>P4: Calculate</b> the resonance and Q-factor or bandwidth in a RLC circuit with series and/or parallel configuration.		
<b>P5: Simulate</b> the correct operation of a rectifier circuit.		
<b>P6: Build</b> and test the operation of a rectifier circuit safely, recording the input and output waveforms.	<b>M3: Explain</b> how the rectification has been achieved, comparing the results of the simulated and physical circuits.	<b>D2: Evaluate</b> the performance of <b>two</b> types of diodes in forward and reverse biasing modes, comparing the voltage and current characteristics.
<b>P7: Identify three</b> operating regions of a bipolar junction transistor (BJT) on a graph.		

Pass	Merit	Distinction
<b>P8: Simulate</b> the correct operation of a BJT amplifier circuit to achieve the given gain.	<b>M4: Explain</b> which class of amplifier has been simulated and built.	<b>D3: Evaluate</b> the performance of the simulated and physical BJT amplifier circuits, giving reasons for any differences.
<b>P9: Build</b> and test the operation of a BJT amplifier circuit safely.		
<b>P10: Design</b> and simulate the correct operation of the combinational logic circuit.	<b>M5: Build</b> and test the correct operation of the combinational logic circuit safely.	<b>D4: Simplify</b> the combinational logic circuit using Boolean laws, comparing the performance with the original simulated circuit.
<b>P11: Design</b> and simulate the correct operation of the sequential logic circuit.	<b>M6: Build</b> and test the correct operation of the sequential logic circuit safely.	<b>D5: Redesign</b> the sequential logic circuit using a different flip-flop type, comparing the simulated performance with that of the original circuit.

### Assessment guidance

This assessment guidance gives you information relating to the assessment criteria. There might not be additional assessment guidance for each assessment criterion. It is included only where it is needed.

Assessment Criteria	Assessment guidance
P1	<ul style="list-style-type: none"> <li>Circuits will contain at least three resistors in series, parallel or combination arrangement, and one or two power sources.</li> <li>Physical circuits could be built using either a breadboard or stripboard method.</li> </ul>
P2	<ul style="list-style-type: none"> <li>The values students are asked to measure in relation to currents, voltages and resistances may change depending on the circuits given in each assignment and changes centres may make to values of the components as appropriate for the resources they have available.</li> </ul>
P3	<ul style="list-style-type: none"> <li>Circuits provided could be RL, RC or RLC in any combination of series or parallel configuration.</li> </ul>
M2	<ul style="list-style-type: none"> <li>Students must provide evidence of the waveform(s) modelled graphically.</li> </ul>
P6	<ul style="list-style-type: none"> <li>Physical circuits could be built using either a breadboard or stripboard method.</li> </ul>
P7	<ul style="list-style-type: none"> <li>Students must provide a graph with their annotations showing the regions of operation for the bipolar junction transistor.</li> </ul>
P8	<ul style="list-style-type: none"> <li>It may be necessary to identify or establish suitable missing resistor/capacitor values in order for circuits to operate as intended, depending on the information provided.</li> </ul>
P9	<ul style="list-style-type: none"> <li>Physical circuits could be built using either a breadboard or stripboard method.</li> </ul>
P10	<ul style="list-style-type: none"> <li>The circuits will need to be designed initially in order to then simulate them.</li> </ul>
M5	<ul style="list-style-type: none"> <li>Physical circuits could be built using either a breadboard or stripboard method.</li> </ul>
M6	



## Synoptic assessment

Some of the knowledge, understanding and skills needed to complete this unit will draw on the learning in Unit F130: Principles of engineering.

This table details these synoptic links.

Unit F137: Electronic devices and circuits		Unit F130: Principles of engineering	
Topic Area		Topic Area	
1	Power sources	3	Electrical/electronic principles
3	Analogue circuits	3	Electrical/electronic principles
4	Digital circuits	3	Electrical/electronic principles

More information about synoptic assessment in these qualifications can be found in **Section 5.2 Synoptic assessment**.

DRAFT

## 5 Assessment and grading

### 5.1 Overview of the assessment

Entry code	H027
Qualification title	OCR Level 3 Cambridge Advanced National (AAQ) in Engineering (Certificate)
GLH	180*
Reference	TBC
Total Units	Has two units: <ul style="list-style-type: none"><li>• Mandatory units F130, F132</li></ul>

Entry code	H127
Qualification title	OCR Level 3 Cambridge Advanced National (AAQ) in Engineering (Extended Certificate)
GLH	360*
Reference	TBC
Total Units	Has nine units: <ul style="list-style-type: none"><li>• Mandatory units F130, F131 and F132</li><li>• and six other units from F133 – F138.</li></ul>

\*the GLH includes assessment time for each unit

<b>Unit F130: Principles of engineering</b>
90 GLH 1 hour 30 minutes written exam 70 marks (70 UMS) OCR-set and marked A scientific calculator is required in this exam. The exam has two parts and all questions are compulsory. There will be short, medium and extended response questions. <ul style="list-style-type: none"><li>• Section A: 35 marks.</li><li>• Section B: 35 marks.</li></ul>

### **Unit F131: Materials science and technology**

60 GLH

1 hour 15 minutes written exam

50 marks (50 UMS)

OCR-set and marked

Calculators are not required in this exam.

The exam has two parts and all questions are compulsory. There will be short, medium and extended response questions.

- Section A: 20 marks.
- Section B: 30 marks.

### **Unit F132: Engineering in practice**

90 GLH

OCR-set assignment

Centre-assessed and OCR-moderated

This set assignment has 9 practical tasks.

It should take 30 GLH to complete.

### **Unit F133: Computer Aided Design (CAD)**

60 GLH

OCR-set assignment

Centre-assessed and OCR- moderated

This set assignment has 2 practical tasks.

It should take 25 GLH to complete.

**Unit F134: Programmable electronics**

60 GLH

OCR-set assignment

Centre-assessed and OCR- moderated

This set assignment has 4 practical tasks.

It should take 20 GLH to complete.

**Unit F135: Mechanical product design**

60 GLH

OCR-set assignment

Centre-assessed and OCR- moderated

This set assignment has 2 practical tasks.

It should take 12 GLH to complete.

**Unit F136: Computer Aided Manufacture (CAM)**

60 GLH

OCR-set assignment

Centre-assessed and OCR- moderated

This set assignment has 5 practical tasks.

It should take 15 GLH to complete.

**Unit F137: Electrical devices and circuits**

60 GLH

OCR-set assignment

Centre-assessed and OCR- moderated

This set assignment has 5 practical tasks.

It should take 20 GLH to complete.

## Unit F138: Mathematics for engineering

60 GLH

1 hour 15 minutes written exam

55 marks (55 UMS)

OCR-set and marked

A scientific calculator is required in this exam.

All questions in the exam are compulsory. There will be short, medium and extended calculation questions.

OCR-set assignments for NEA units are on our secure website, **Teach Cambridge**.

### 5.2 Synoptic assessment

Synoptic assessment is a built-in feature of these qualifications. It means that students need to use an appropriate selection of their knowledge, understanding and skills developed across each qualification in an integrated way and apply them to a key task or tasks.

This helps students to build a holistic understanding of the subject and the connections between different elements of learning, so they can go on to apply what they learn from these qualifications to new and different situations and contexts.

The externally assessed units allow students to gain underpinning knowledge and understanding relevant to engineering. The NEA units draw on and strengthen this learning by assessing it in an applied or practical way.

It is important to be aware of the synoptic links between the units so that teaching, learning and assessment can be planned accordingly. Then students can apply their learning in ways which show they are able to make connections across the qualification. **Section 4.3** shows the synoptic links for each unit.

### 5.3 Transferable skills

These qualifications give students the opportunity to gain broad, transferable skills and experiences that they can apply in future study, employment and life.

Higher Education Institutions (HEIs) have told us that developing some of these skills helps students to transition into higher education.

These skills include:

- Collaboration
- Communication
- Creativity
- Critical thinking
- Independent learning
- Presentation skills
- Problem solving
- Project and team-based working
- Reflection

- Research skills
- Resilience
- Risk taking
- Self-directed study
- Time management

## 5.4 Grading and awarding grades

### Externally assessed units

We mark all the externally assessed units.

Each external assessment is marked according to a mark scheme, and the mark achieved will determine the unit grade awarded (Pass, Merit or Distinction). We determine grade boundaries for each of the external assessments in each assessment series.

If a student doesn't achieve the mark required for a Pass grade, we issue an unclassified result for that unit. The marks achieved in the external assessment will contribute towards the student's overall qualification grade, even if a Pass is not achieved in the unit assessment.

### NEA units

NEA units are assessed by the teacher and externally moderated by us.

Each unit has specified Pass, Merit and Distinction assessment criteria. The assessment criteria for each unit are provided with the unit content in **Section 4.3** of this specification. Teachers must judge whether students have met the criteria or not.

A unit grade can be awarded at Pass, Merit or Distinction. The number of assessment criteria needed to achieve each grade has been built into each assignment. These are referred to as design thresholds. The table below shows the design thresholds for each grade outcome for the NEA assessments in these qualifications. The unit grade awarded is based on the **total** number of achieved criteria for the unit. The total number of achieved criteria for each unit can come from achievement of any of the criteria (Pass, Merit or Distinction). This is **not** a 'hurdles-based' approach, so students do **not** have to achieve **all** criteria for a specific grade to achieve that grade (e.g. all Pass criteria to achieve a Pass).

To make sure we can keep outcomes fair and comparable over time, we will review the performance of the qualifications through their lifetime. The review process might lead to changes in these design thresholds if any unexpected outcomes or significant changes are identified.

Unit size (GLH)	60	90
Total number of criteria	22	28
Number of pass criteria	11	14
Number of merit criteria	6	8
Number of distinction criteria	5	6
Total number of criteria needed for a unit pass	9	12
Total number of criteria needed for a unit merit	13	17
Total number of criteria needed for a unit distinction	18	23

If a student doesn't achieve enough criteria to achieve a unit Pass, we will issue an unclassified result for that unit. The number of criteria achieved will be converted into a mark on the Uniform Mark Scale (UMS) and will contribute towards the student's overall qualification grade, even if a Pass is not achieved in the unit assessment. More information about this is in Section below (**Calculating the qualification grades**).

## Qualifications

The overall qualification grades are:

- Distinction\* (D\*)
- Distinction (D)
- Merit (M)
- Pass (P)
- Unclassified (U)

## Calculating the qualification grades

When we work out students' overall grades, we need to be able to compare performance on the same unit in different assessments over time and between different units. We use a Uniform Mark Scale (UMS) to do this.

A student's uniform mark for each externally assessed unit is calculated from the student's raw mark on that unit. A student's uniform mark for each NEA unit is calculated from the number of criteria the student achieves for that unit. The raw mark or number of criteria achieved are converted to the equivalent mark on the uniform mark scale. Marks between grade boundaries are converted on a pro rata basis.

When unit results are issued, the student's unit grade and uniform mark are given. The uniform mark is shown out of the maximum uniform mark for the unit (for example, 48/60).

The student's uniform marks for each unit will be aggregated to give a total uniform mark for the qualification. The student's overall grade will be determined by the total uniform mark.

The tables below show:

- the maximum raw marks or number of criteria, and uniform marks for each unit in the qualifications
- the uniform mark boundaries for each of the assessments in each qualification
- the minimum total mark for each overall grade in the qualifications.

## Certificate Qualification:

Unit	Maximum raw mark/number of criteria	Maximum uniform mark (UMS)	Distinction* (UMS)	Distinction (UMS)	Merit (UMS)	Pass (UMS)
F130	70	70	-	56	42	28
F132	28	70	-	56	42	28
Qualification Totals	98	140	126	112	84	56

## Extended Certificate Qualification:

Unit	Maximum raw mark/number of criteria	Maximum uniform mark (UMS)	Distinction* (UMS)	Distinction (UMS)	Merit (UMS)	Pass (UMS)
F130	70	70	-	56	42	28
F131	50	50	-	40	30	20
F132	28	70	-	56	42	28
F133	22	55	-	44	33	22
F134	22	55	-	44	33	22
F135	22	55	-	44	33	22
F136	22	55	-	44	33	22
F137	22	55	-	44	33	22
F138	55	55	-	44	33	22
Qualification Totals	192/225	300	270	240	180	120

You can find a marks calculator on the qualification page of the OCR website to help you convert raw marks/number of achieved criteria into uniform marks.

### 5.5 Performance descriptors

Performance descriptors indicate likely levels of attainment by representative students performing at the Pass, Merit and Distinction grade boundaries at Level 3.

The descriptors must be interpreted in relation to the content in the units and the qualification as a whole. They are not designed to define that content. The grade achieved will depend on how far the student has met the assessment criteria overall. Shortcomings in some parts of the assessment might be balanced by better performance in others.

#### Level 3 Pass

At Pass, students show adequate knowledge and understanding of the basic elements of much of the content being assessed. They can develop and apply their knowledge and understanding to some basic and familiar contexts, situations and problems.

Responses to higher order tasks involving detailed discussion, evaluation and analysis are often limited.

Many of the most fundamental skills and processes relevant to the subject are executed effectively but lack refinement, producing functional outcomes. Demonstration and application of more advanced skills and processes might be attempted but not always executed successfully.

#### Level 3 Merit

At Merit, students show good knowledge and understanding of many elements of the content being assessed. They can sometimes develop and apply their understanding to different contexts, situations and problems, including some which are more complex or less familiar.

Responses to higher order tasks involving detailed discussion, evaluation and analysis are likely to be mixed, with some good examples at times and others which are less accomplished.

Skills and processes relevant to the subject, including more advanced ones, are developed in terms of range and quality. They generally lead to outcomes which are of good quality, as well as being functional.



### **Level 3 Distinction**

At Distinction, students show thorough knowledge and understanding of most elements of the content being assessed. They can consistently develop and apply their understanding to different contexts, situations and problems, including those which are more complex or less familiar.

Responses to higher order tasks involving detailed discussion, evaluation and analysis are successful in most cases.

Most skills and processes relevant to the subject, including more advanced ones, are well developed and consistently executed, leading to high quality outcomes.

DRAFT

## 6 Non examined assessment (NEA) units

This section gives guidance on completing the NEA units. In the NEA units, students build a portfolio of evidence to meet the assessment criteria for the unit.

Assessment for these qualifications **must** adhere to JCQ's **Instructions for Conducting Coursework**. Do **not** use JCQ's Instructions for Conducting Non-examination Assessments – these are only relevant to GCE and GCSE specifications.

The NEA units are centre-assessed and externally moderated by us.

You **must** read and understand all the rules and guidance in this section **before** your students start the set assignments.

If you have any questions, please contact us for help and support.

### 6.1 Preparing for NEA unit delivery and assessment

#### 6.1.1 Centre and teacher/assessor responsibilities

We assume the teacher is the assessor for the NEA units.

**Before** you apply to us for approval to offer these qualifications you must be confident your centre can fulfil all the responsibilities described below. Once you're approved, you can offer any of our general qualifications, Cambridge Nationals or Cambridge Advanced Nationals (AAQs) **without** having to seek approval for individual qualifications.

Here's a summary of the responsibilities that your centre and teachers must be able to fulfil. It is the responsibility of the head of centre<sup>1</sup> to make sure our requirements are met. The head of centre must ensure that:

- there are enough trained or qualified people to teach and assess the expected number of students you have in your cohorts.
- teaching staff have the relevant level of subject knowledge and skills to deliver and assess these qualifications.
- teaching staff will fully cover the knowledge, understanding and skills requirements in teaching and learning activities.
- allowed combinations of units are considered at the start of the course to be confident that all students can access a valid route through the qualifications.
- all necessary resources are available for teaching staff and students during teaching and assessment activities. This gives students every opportunity to meet the requirements of the qualification and reach the highest grade possible.
- there is a system of internal standardisation in place so that all assessment decisions for centre-assessed assignments are consistent, fair, valid and reliable (see **Section 6.4.3**).
- there is enough time for effective teaching and learning, assessment and internal standardisation.
- processes are in place to make sure that students' work is individual and confirmed as authentic (see **Section 6.2.1**).

---

<sup>1</sup> This is the most senior officer in the organisation, directly responsible for the delivery of OCR qualifications, For example, the headteacher or principal of a school/college. The head of centre accepts full responsibility for the correct administration and conduct of OCR exams.

- OCR-set assignments are used for students' summative assessments.
- OCR-set assignments are **not** used for practice. Sample assessment material for each of the NEA units is available on the OCR website. This sample assessment material can be used for practice purposes.
- students understand what they need to do to achieve the criteria.
- students understand what it means when we say work must be authentic and individual and they (and you) follow our requirements to make sure their work is their own.
- students know they must not reference another individual's personal details in any evidence produced for summative assessment, in accordance with the Data Protection Act 2018 and the UK General Data Protection Regulations (UK GDPR). It is the student's responsibility to make sure evidence that includes another individual's personal details is anonymised.
- outcomes submitted to us are correct and are accurately recorded.
- assessment of set assignments adheres to the JCQ **Instructions for Conducting Coursework** and JCQ **AI Use in Assessments: Protecting the Integrity of Qualifications**.
- a declaration is made at the point you're submitting any work to us for assessment that confirms:
  - all assessment is conducted according to the specified regulations identified in the **Administration** area of our website,
  - students' work is authentic.
  - marks have been transcribed accurately.
- centre records and students' work are kept according to these requirements:
  - students' work **must** be kept until **after** the unit has been awarded and any review of results or appeals processed. We cannot consider any review if the work has not been kept.
  - internal standardisation and assessment records must be kept securely for a minimum of three years after the date we've issued a certificate for a qualification.
- all cases of suspected malpractice involving teachers or students are reported (see **Section 6.3.1**).

## 6.2 Requirements and guidance for delivering and marking the OCR-set assignments

The assignments are:

- set by us.
- taken under supervised conditions (unless we specify otherwise in the assessment guidance)
- assessed by the teacher.
- moderated by us.

You can find the set assignments on our secure website, **Teach Cambridge**.

The set assignments give an approximate time that it will take to complete all the tasks. These timings are for guidance only, but should be used by you, the teacher, to give students an indication of how long to spend on each task. You can decide how the time should be allocated

between each task or part task. Students can complete the tasks and produce the evidence across several sessions. Student evidence must be securely stored between supervised sessions.

We will publish a new set assignment each year and they will be live for two years(s). Each new set assignment will be released on 1 June. You must check our secure website, **Teach Cambridge**, and use a set assignment that is live for assessment. The live assessment dates will be shown on the front cover. Students are allowed one resubmission of work based on the same live assignment.

You must have made unit entries before submitting NEA work for moderation.

**Appendix A** of this specification gives guidance for creating electronic evidence for the NEA units. Read Appendix A in conjunction with the unit content and assessment criteria grids to help you plan the delivery of each unit.

The rest of this section is about how to manage the delivery and marking of the set assignments so that assessment is valid and reliable. Please note that failing to meet these requirements might be considered as malpractice.

Here is a summary of what you need to do.

You **must**:

- have covered the knowledge, understanding and skills with your students and be sure they are ready for assessment **before** you start the summative assessment.
- use an OCR-set assignment for summative assessment of the students.
- give students the **Student Guide** before they start the assessment.
- familiarise yourself with the assessment guidance relating to the tasks. The assessment guidance for each unit is in **Section 4** after the assessment criteria grids and with the student tasks in the assignments.
- make sure students are clear about the tasks they must complete and the assessment criteria they are attempting to meet.
- give students a reasonable amount of time to complete the assignments and be fair and consistent to all students. The estimated time we think each assignment should take is stated in the OCR-set assignments. In that time students can work on the tasks under the specified conditions until the date that you collect the work for centre assessment.
- tell the students the resources they can use in the assignment before they start the assessment tasks.
- only give students OCR-provided templates. If they choose to use a different template from a book, a website or course notes (for example, to create a plan) they **must** make sure the source is referenced.
- monitor students' progress to make sure work is capable of being assessed against the assessment criteria, on track for being completed in good time and is the student's own work:
  - NEA work must be completed in the centre under teacher supervision in normal curriculum time:
    - work must be completed with enough supervision to make sure that it can be authenticated as the student's own work. You must be familiar with the requirements of the JCQ document **AI Use in Assessments: Protecting the Integrity of Qualifications** before assessment starts.

There may be exceptions to the requirement for supervised conditions if there is work to complete to support the assignment tasks (e.g. research). The assignment and assessment guidance will specify if there are exceptions.

Where students are allowed to complete work outside of supervised conditions (e.g. research that may be allowed between supervised sessions) you must make sure that they only bring notes relating to the work they are allowed to complete unsupervised into the supervised sessions (e.g. notes relating to the research they have done). They must not use unsupervised time as an opportunity to:

- Create drafts of work for their tasks.
  - Gather information to use in other aspects of their tasks.
  - if you provide any material to prepare students for the set assignment, you must adhere to the rules on using referencing and on acceptable levels of guidance to students. This is in section **6.2.3 and 6.3**.
  - students must produce their work independently (see sections **6.2.1 and 6.3**).
  - you must make sure students know to keep their work and passwords secure. They must not share them with other students.
- complete the **Teacher Observation Record** that is with the assignments for tasks that state it is needed. You **must** follow the guidance given when completing it.
  - use the assessment criteria to assess students' work.
  - before submitting a final outcome to us, you can allow students to repeat any part of the assignment and rework their original evidence. But any feedback you give to students on the original (assessed) evidence, must:
    - only be generic.
    - be recorded.
    - be available to the OCR assessor.

(See **Section 6.3 on Feedback** and **Section 6.4.4 on resubmitting work**).

You **must not**:

- make any changes to the OCR-set assignments outside of those allowed (see the **Information and instructions for teachers** section of the assignment).
- accept multiple resubmissions of work where small changes have been made in response to feedback.
- allow teachers or students to add, amend or remove any work **after** students have submitted work for moderation. This will constitute malpractice.
- give detailed advice and suggestions to individuals or the whole class on how work may be improved to meet the assessment criteria.
- allow students access to their assignment work between teacher supervised sessions. (There may be exceptions where students are allowed to complete work independently (e.g. research). Any exceptions will be stated in the assignments.)
- practice the live OCR-set assignment tasks with the students.

### 6.2.1 Scope of assessment modification

The set assignments for each unit are designed to meet the unit content and assessment criteria. To make sure that the assessments remain fair and reliable, only limited modification is allowed.

The set assignments for Units F132 and F137 tell you the modifications allowed, you must make sure that students can still cover all topic areas and access the full range of assessment criteria.

You do not have to send your modified assignment to us for checking before you give it to your students. You **must** make your modified assignment available to the OCR assessor when you submit your sample for moderation. This allows the OCR assessor to:

- make moderation decisions based on the assignment completed by the students.
- know that they don't need to report group approaches that are different to the OCR-set assignment as malpractice.

### 6.2.2 Ways to authenticate work

You must use enough supervision and complete enough checks to be confident that the work you mark is the student's own and was produced independently.

Where possible, you should discuss work in progress with students. This will make sure that work is being completed in a planned and timely way and will give you opportunities to check the authenticity of the work.

You **must**:

- have read and understood the JCQ document **AI Use in Assessments: Protecting the Integrity of Qualifications**.
- make sure students and other teachers understand what constitutes plagiarism.
- not accept plagiarised work as evidence.
- use supervision and questioning as appropriate to confirm authenticity.
- make sure students and teachers fill in declaration statements.

### 6.2.3 Group work

Group work is not allowed for the NEA assignments in these qualifications.

### 6.2.4 Plagiarism

Students must use their own words when they produce final written pieces of work to show they have genuinely applied their knowledge and understanding. When students use their own words, ideas and opinions, it reduces the possibility of their work being identified as plagiarised.

Plagiarism is:

- the submission of someone else's work as your own
- failure to acknowledge a source correctly, including any use of Artificial Intelligence (AI).

You might find the following JCQ documents helpful:

- **Plagiarism in Assessments**

- **AI Use in Assessments: Protecting the Integrity of Qualifications**

Due to increasing advancements in AI technology, we strongly recommend that you are familiar with the likely outputs from AI tools. This could include using AI tools to produce responses to some of the assignment tasks, so that you can identify typical formats and wording that these may produce. This may help you identify any cases of potential plagiarism from students using AI tools to generate written responses.

Plagiarism makes up a large percentage of cases of suspected malpractice reported to us by our assessors. You must **not** accept plagiarised work as evidence.

Plagiarism often happens innocently when students do not know that they must reference or acknowledge their sources or aren't sure how to do this. It's important to make sure your students understand:

- the meaning of plagiarism and what penalties may be applied.
- that they can refer to research, quotations or evidence produced by somebody else, but they must list and reference their sources and clearly mark quotations.
- quoting someone else's work, even when it's properly sourced and referenced, doesn't evidence understanding. The student must 'do' something with that information to show they understand it. For example, if a student has to analyse data from an experiment, quoting data doesn't show that they understand what it means. The student must interpret the data and, by relating it to their assignment, say what they think it means. The work must clearly show how the student is using the material they have referenced to inform their thoughts, ideas or conclusions.

We have **The OCR Guide to Referencing** on our website. We have also produced a **poster** about referencing and plagiarism which may be useful to share with your students.

Teach your students how to reference and explain why it's important to do it. At Key Stage 5 they must:

- use quote marks to show the beginning and end of the copied work.
- list the html address for website text and the date they downloaded information from the website.
- for other publications, list:
  - the name of the author.
  - the name of the resource/book/printed article.
  - the year in which it was published.
  - the page number.

Teach your students to:

- always reference material copied from the internet or other sources. This also applies to infographics (graphical information providing data or knowledge).
- always identify information they have copied from teaching handouts and presentations for the unit, using quote marks and stating the text is from class handouts.

## Identifying copied/plagiarised work

Inconsistencies throughout a student's work are often indicators of plagiarism. For example:

- different tones of voice, sentence structure and formality across pieces of work.
- use of American expressions, spellings and contexts (such as American laws and guidelines).
- dated expressions and references to past events as being current.
- sections of text in a document where the font or format is inconsistent with other sections.

## What to do if you think a student has plagiarised

If you identify plagiarised work during assessment or internal standardisation, you must:

- consider the plagiarism when judging the number of assessment criteria achieved.
  - if the work is part of the moderation sample, it must be included with the other work provided to the OCR assessor. You must add a note on the Unit Recording Sheet to state that there is plagiarism in the work and the number of criteria achieved has been adjusted accordingly.
- report the student(s) for plagiarism in line with the JCQ document **Suspected Malpractice Policies and Procedures**
  - fill in the **JCQ form M1**.

In line with Jcq's policies and procedures on suspected malpractice, the penalties applied for plagiarism will usually result in the work not being allowed or the mark being significantly reduced.

## 6.3 Feedback

### Feedback to students on work in progress towards summative assessment

You can discuss work in progress towards summative assessment with students to make sure it's being done in a planned and timely way. It also provides an opportunity to check the authenticity of the work. You must intervene if there's a health and safety risk (and reflect this in your assessment if the student's ability to operate safely and independently if that is part of the criteria).

Generic guidance to the whole class is also allowed. This could include reminding students to check they have provided evidence to cover all key aspects of the task. Individual students can be prompted to double check for gaps in evidence providing that specific gaps are not pointed out to them.

You can give general feedback and support if one or more students are struggling to get started on an aspect of the assignment or following a break between sessions working on the assignment. For example, if a student is seeking more guidance that suggests they are not able to apply knowledge, skills and understanding to complete their evidence, you can remind them that they had a lesson which covered the topic. The student would then need to review their own notes to find this information and apply it as needed.

Feedback must not provide specific advice and guidance that would be construed as coaching. This would compromise the student's ability to independently perform the task(s) they are doing and constitutes malpractice. Our assessors use a number of measures to assure themselves the work is the student's own.

Once work has been assessed, you must give feedback to students on the work they submitted for assessment.



Feedback **must**:

- be supportive, encouraging and positive.
- tell the student what has been noticed, not what the teacher thinks (for example, if you have observed the student completing a task, you can describe what happened, what was produced and what was demonstrated).

Feedback **can**:

- identify what task and part of the task could be improved, but not say how to improve it. You could show the student work from a **different** unit that demonstrates higher achievement, but you must not detail to the student how they could achieve that in their work. If you are using another student's work from a different unit as an example, you must anonymise this work and make sure that the potential to plagiarise from this work is minimised. You could remind students that they had a lesson on a specific topic and that they could review their notes, but you must not tell them how they could apply the teaching to improve their work.
- comment on what has been achieved, for example 'the evidence meets the P2 and M2 criteria'.
- identify that the student hasn't met a command word or assessment criteria requirement. For example, 'This is a description, not an evaluation'.
- use text from the specification, assignment or assessment criteria in general guidance to clarify what is needed in the work. For example, 'You explained how the prototype contributes to the function of the product (M1)'.

Feedback **must not**:

- point out specific gaps. For example, you must not prompt the student to include specific detail in their work, such as 'You need to measure all components using a steel rule'.
- be so detailed that it leads students to the answer. For example, you must not give:
  - model answers.
  - step-by-step guidance on what to do to complete or improve work.
  - headings or templates that include examples which give all or part of what students have to write about or produce.
- talk the student through how to achieve or complete the task.
- give detail on where to find information/evidence.

In other words, feedback must help the student to take the initiative in making changes. It must not direct or tell the student what to do to complete or improve their work in a way that means they do not need to think how to apply their learning. Students need to recall or apply their learning. You must not do the work for them.

Neither you nor the student can add, amend or remove any work after the final mark has been submitted for moderation.

Please see additional guidance for students who wish to resubmit their work following OCR moderation in **Section 6.4.4**.

## What over-direction might look like

When we see anything that suggests the teacher has led students to the answer, we become concerned because it suggests students have not worked independently to produce their assignment work. The following are examples of what might indicate over-direction by the teacher:

- prompts that instruct students to include specific detail in their work, such as, 'You need to include the aims of the activity. Who is it aimed at? What is the purpose of the activity? How will it benefit the specific group/individual?
- headings or templates that include examples which give all or part of what students have to write about or produce, such as sources of support.

OCR Assessors will report suspected malpractice when they cannot see differences in content between students' work in the sample they are moderating. An exception is when students have only used and referenced technical facts and definitions. If the OCR assessor is in any doubt, they will report suspected malpractice. The decision to investigate or not is made by us, not the assessor.

### 6.3.1 Reporting suspected malpractice

It is the responsibility of the head of centre to report all cases of suspected malpractice involving teachers or students.

A JCQ Report of Suspected Malpractice form (JCQ/M1 for student suspected malpractice or JCQ/M2 for staff suspected malpractice) is available to download from the **JCQ website**. The form must be completed as soon as possible and emailed to us at **malpractice@ocr.org.uk**.

When we ask centres to gather evidence to assist in any malpractice investigation, heads of centres must act promptly and report the outcomes to us.

The JCQ document **Suspected Malpractice Policies and Procedures** has more information about reporting and investigating suspected malpractice, and the possible sanctions and penalties which could be imposed. You can also find out more on our **website**.

### 6.3.2 Student and centre declarations

Both students and teachers must declare that the work is the student's own:

- **each student** must sign a declaration before submitting their work to their teacher. A **candidate authentication statement** can be used and is available to download from our **website**. You must keep these statements in the centre until all enquiries about results, malpractice and appeal issues have been resolved. You **must** record a mark of zero if a student cannot confirm the authenticity of their work.
- **teachers** must declare the work submitted for centre assessment is the students' own work by completing a **centre authentication form (CCS160)** for each unit. You must keep centre authentication forms in the centre until all post-results issues have been resolved.

### 6.3.3 Generating evidence

The set assignments will tell the students what they need to do to meet the assessment criteria for the NEA units. It is your responsibility to make sure that the methods of generating evidence for the assignments are:

- valid
- safe and manageable
- suitable to the needs of the student.

## Valid

The evidence presented must be valid. For example, it would not be appropriate to present an organisation's equal opportunities policy as evidence towards a student's understanding of how the equal opportunities policy operates in an organisation. It would be more appropriate for the student to incorporate the policy in a report describing the different approaches to equal opportunities.

## Safe and manageable

You must make sure that methods of generating evidence are safe and manageable and do not put unnecessary demands on the student.

## Suitable to the needs of the student

We are committed to ensuring that achievement of these qualifications is free from unnecessary barriers.

You must follow this commitment through when modifying tasks (where this is allowed) and/or considering assessment and evidence generation. If you are modifying tasks and are not sure what is acceptable, **contact us**.

## Observation and questioning

The primary evidence for assessment is the work submitted by the student, however the following assessment methods might be suitable for teachers/assessors to use for some aspects of these qualifications, where identified:

- **observation** of a student doing something
- **questioning** of the student or witness.

### Observation

The teacher/assessor and student should plan observations together, but it is the teacher's/assessor's responsibility to record the observation properly (for example observing a student undertaking a practical task). More information is in the Teacher Observation Records section.

### Questioning

Questioning the student is normally an ongoing part of the formative assessment process and may, in some circumstances, provide evidence to support achievement of the criteria.

Questioning is often used to:

- test a student's understanding of work which has been completed outside of the classroom
- check if a student understands the work they have completed
- collect information on the type and purpose of the processes a student has gone through.

If questioning is used as evidence towards achievement of specific topic areas, it is important that teachers/assessors record enough information about what they asked and how the student replied, to allow the assessment decision to be moderated.

### 6.3.4 Teacher Observation Records

You **must** complete the Teacher Observation Record form in the OCR-set assignment for:

**Unit F132** for each student as evidence of manufacturing a mechanical prototype (Task 4, Topic Area 4). The Teacher Observation Record form must describe whether the processes and equipment/tools were set-up, operated and shutdown appropriately and whether their use was appropriate to the required task.

**Unit F132** for each student as evidence of manufacturing a prototype of an electronic circuit (Task 8, Topic Area 4). The Teacher Observation Record form must describe whether the processes and equipment/tools were set-up, operated and shutdown appropriately and their use was appropriate to the required task, including evidence of sustainability considerations being taken into account.

**Unit F134** for each student as evidence of designing and assembling a prototype programmable microcontroller system (Task 2, Topic Areas 2 and 3). The Teacher Observation Record form must detail the assembly methods used and confirm adherence to safe working practices.

**Unit F136** for each student as evidence of manufacturing a component using a subtractive process (Task 3, Topic Area 3). The Teacher Observation Record form must record the independence and competence of students when setting up, using and shutting down the machine.

**Unit F136** for each student as evidence of manufacturing a component using an additive process (Task 4, Topic Area 4). The Teacher Observation Record form must record the independence and competence of students when setting up, using and shutting down the machine.

Teacher observation **cannot** be used as evidence of achievement for a whole unit. Most evidence **must** be produced directly by the student. Teacher observation **must only** be used where specified as an evidence requirement.

Teacher Observation Records must be suitably detailed for each student, to help assessors to determine if the assessment criteria have been met. You must follow the guidance provided in the 'guidance notes' section of the form so that the evidence captured and submitted is appropriate. Both you and the student must sign and date the form to show that you both agree its contents.

Where the guidance has not been followed, the reliability of the form as evidence may be called into question. If doubt about the validity of the Teacher Observation Record form exists, it cannot be used as assessment evidence and marks based on it cannot be awarded. OCR assessors will be instructed to adjust centre marks accordingly.

### 6.3.5 Presentation of the final piece of work

Students must submit their evidence in the format specified in the tasks where specific formats are given. Written work can be word processed or hand-written and tables and graphs (if relevant) can be produced using appropriate ICT.

Any sourced material must be suitably acknowledged. Quotations must be clearly marked and a reference provided.

A completed Unit Recording Sheet (URS) must be attached to work submitted for moderation.

The URS can be downloaded from the qualification webpage. Centres **must** show on the URS where specific evidence can be found. The URS tells you how to do this.

Work submitted digitally for moderation should be on electronic media (for example, on our portal, CD or USB Drive). Work **must** be in a suitable file format and structure. **Appendix A** gives more guidance about submitting work in digital format.

## 6.4 Assessing NEA units

All NEA units are assessed by teachers and externally moderated by OCR assessors. Assessment of the set assignments must adhere to JCQ's **Instructions for Conducting Coursework**.

The centre is responsible for appointing someone to act as the internal assessor. This would usually be the teacher who has delivered the programme but could be another person from the centre. The assessment criteria must be used to assess the student's work. These specify the levels of skills, knowledge and understanding that the student needs to demonstrate.

### 6.4.1 Applying the assessment criteria

When students have completed the assignment, they must submit their work to you to be assessed.

You must assess the tasks using the assessment criteria and any additional assessment guidance provided. Each criterion states what the student needs to do to achieve that criterion (e.g. Simulate the electronic circuit to demonstrate its correct operation). The command word and assessment guidance provide additional detail about breadth and depth where it is needed.

You must judge whether each assessment criterion has been **successfully achieved** based on the evidence that a student has produced. For the criterion to be achieved, the evidence must show that all aspects have been met in sufficient detail.

When making a judgement about whether a criterion has been **successfully achieved**, you must consider:

- the requirements of the NEA task
- the criterion wording, including the command word used and its definition
- any assessment guidance for the criterion
- the unit content that is being assessed.

You must annotate the work to show where evidence meets each criterion (see **Section 6.4.2**). You can then award the criterion on the Unit Recording Sheet (URS). Assessment should be positive, rewarding achievement rather than penalising failure or omissions.

The number of criteria needed for each unit grade (Pass, Merit or Distinction) is provided in **Section 5**.

You must complete a Unit Recording Sheet (URS) for each unit a student completes. On the URS you must identify:

- whether the student has met each criterion or not (by adding a tick (✓) or X in the column titled **Assessment criteria achieved**)
  - you should also indicate where the evidence can be found if a '✓' is identified.
  - a X indicates that there is insufficient evidence to fully meet the criterion or it was not attempted.
- the total number of criteria achieved by the student for the unit.

You must be convinced, from the evidence presented, that students have worked independently to the required standard.

Your centre must internally standardise the assessment decisions for the cohort **before** you give feedback to students (see **Section 6.4.3**). When you are confident the internal assessment and standardisation process is complete, you can submit work for moderation at the relevant time. You **must not** add, amend or remove any work after it has been submitted to us for final moderation.

### 6.4.2 Annotating students' work

Each piece of NEA work must show how you are satisfied the assessment criteria have been met.

Comments on students' work and the Unit Recording Sheet (URS) provide a means of communication between teachers during internal standardisation, and with the OCR assessor if the work is part of the moderation sample.

### 6.4.3 Internal standardisation

It is important that all teachers are assessing work to common standards. For each unit, centres must make sure that internal standardisation of outcomes across teachers and teaching groups takes place using an appropriate procedure.

This can be done in a number of ways. In the first year, reference material and OCR training meetings will provide a basis for your centre's own standardisation. In following years, this, and/or your own centre's archive material, can be used. We advise you to hold preliminary meetings of staff involved to compare standards through cross-marking a small sample of work. After you have completed most of the assessment, a further meeting at which work is exchanged and discussed will help you make final adjustments.

If you are the only teacher in your centre assessing these qualifications, we still advise you to make sure your assessment decisions are internally standardised by someone else in your centre. Ideally this person will have experience of these types of qualifications, for example someone who:

- is delivering a similar qualification in another subject.
- has relevant subject knowledge.

You must keep evidence of internal standardisation in the centre for the OCR assessor to see.

We have a **guide** to how internal standardisation can be approached on our website.

### 6.4.4 Resubmitting work to OCR to improve the grade

As described in **Section 6.2**, before submitting a final outcome to us, you can allow students to repeat any element of the assignment and rework their original evidence. We refer to this as a 'resubmission'. This is to allow the student to reflect on feedback, which must be recorded, and improve their work. It is **not** an iterative process where they make small modifications through ongoing feedback to eventually achieve the desired grade.

### 6.4.5 Submitting outcomes

When you have assessed the work and it has been internally standardised, outcomes can be submitted to us. For the purpose of submission, outcomes will be considered as 'marks'. You will submit the total number of criteria achieved for units as marks. You can find the key dates and timetables on our **website**.

There should be clear evidence that work has been attempted and some work produced. If a student does not submit any work for a NEA unit, the student should be identified as being absent from that unit.

If a student completes any work at all for a NEA unit, you must assess the work using the assessment criteria and award the appropriate number of criteria. This might be zero.

## 6.5 Moderating NEA units

The purpose of external moderation is to make sure that the standard of assessment is the same for all centres and that internal standardisation has taken place.

The administration pages of our **website** give full details about how to submit work for moderation.

This includes the deadline dates for entries and submission of marks. For moderation to happen, you must submit your marks by the deadline.

### 6.5.1 Sample requests

Once you have submitted your marks, we will tell you which work will be sampled as part of the moderation process. Samples will include work from across the range of students' attainment. Copies of students' work must be kept until after their qualifications have been awarded and any review of results or appeals processed.

Centres will receive the final outcomes of moderation when the provisional results are issued. Results reports will be available for you to access. More information about the reports that are available is on our website.

We need sample work to help us monitor standards. We might ask some centres to release work for this purpose. We will let you know as early as possible if we need this from you. We always appreciate your co-operation.

DRAFT

## 7 Administration

This section gives an overview of the processes involved in administering these qualifications. Some of the processes require you to submit something to OCR by a specific deadline. More information about the processes and deadlines involved at each stage is on our **administration pages**.

### 7.1 Assessment availability

There are two assessment opportunities available each year for the externally assessed units: one in January and one in June. Students can be entered for different units in different assessment series.

All students must take the exams at a set time on the same day in a series.

NEA assignments can be taken by students at any time during the live period shown on the front cover. There are two windows each year to submit NEA outcomes. Submission of student outcomes will initiate the moderation visit by the OCR Assessor.

You must make unit entries for students before you can submit outcomes to request a visit. All dates relating to NEA moderation are on our administration pages.

Qualification certification is available at each results release date.

### 7.2 Equality Act information relating to Cambridge Advanced Nationals (AAQs)

The Cambridge Advanced Nationals (AAQs) require assessment of a broad range of skills and, as such, prepare students for further study and higher-level courses.

The Cambridge Advanced Nationals (AAQs) qualifications have been reviewed to check if any of the competences required present a potential barrier to disabled students. If this was the case, the situation was reviewed again to make sure that such competences were included only where essential to the subject.

### 7.3 Accessibility

There can be adjustments to standard assessment arrangements based on the individual needs of students. It is important that you identify as early as possible if students have disabilities or particular difficulties that will put them at a disadvantage in the assessment situation and that you choose a qualification or adjustment that allows them to demonstrate attainment.

If a student requires access arrangements that need approval from us, you must use **Access arrangements (online)** to gain approval. You must select the appropriate qualification type(s) when you apply. Approval for GCSE or GCE applications alone does not extend to other qualification types. You can select more than one qualification type when you make an application. For guidance or support please contact the **OCR Special Requirements Team**.

The responsibility for providing adjustments to assessment is shared between your centre and us. Please read the JCQ document **Access Arrangements and Reasonable Adjustments**.

If you have students who need a post-exam adjustment to reflect temporary illness, indisposition or injury when they took the assessment, please read the JCQ document **A guide to the special consideration process**.

If you think any aspect of these qualifications unfairly restricts access and progression, please email **Support@ocr.org.uk** or call our Customer Support Centre on **01223 553998**.



The following access arrangements are allowed for this specification:

Access arrangement	Type of assessment
Reader/Computer reader	All assessments
Scribes/Speech recognition technology	All assessments
Practical assistants	All assessments
Word processors	All assessments
Communication professional	All assessments
Language modifier	All assessments
Modified question paper	Timetabled exams
Extra time	All assessments with time limits

## 7.4 Requirements for making an entry

We provide information on key dates, timetables and how to submit marks on our **website**.

Your centre must be registered with us to make entries. We recommend that you apply to become a registered centre with us well in advance of making your first entries. Details on how to register with us are on our **website**.

It is essential that unit entry codes are stated in all correspondence with us.

### 7.4.1 Making estimated unit entries

Estimated entries are not needed for Cambridge Advanced Nationals (AAQs) qualifications.

### 7.4.2 Making final unit entries

When you make an entry, you must state the unit entry codes and the component codes. Students submitting work must be entered for the appropriate unit entry code from the table below.

The short title for these Cambridge Advanced Nationals (AAQs) is CAMTECH. This is the title that will be displayed on our secure website, **Interchange**, and some of our administrative documents.

You do **not** need to register your students first. **Individual unit entries should be made for each series in which you intend to submit or resubmit a NEA unit or sit an externally assessed examination.**

Make a certification entry using the overall qualification code (see **Section 7.5**) in the final series only.

Unit entry code	Component code	Assessment method	Unit titles
F130	01	Written paper	Principles of engineering
F131	01	Written paper	Materials science and technology
F132A	01	Visiting	Engineering in practice
F132B	02	Remote	Engineering in practice
F133A	01	Visiting	Computer Aided Design (CAD)
F133B	02	Remote	Computer Aided Design (CAD)
F134A	01	Visiting	Programmable electronics
F134B	02	Remote	Programmable electronics
F135A	01	Visiting	Mechanical product design
F135B	02	Remote	Mechanical product design
F136A	01	Visiting	Computer Aided Manufacture (CAM)

F136B	02	Remote	Computer Aided Manufacture (CAM)
F137A	01	Visiting	Electrical devices and circuits
F137B	02	Remote	Electrical devices and circuits
F138	01	Written paper	Mathematics for engineering

## 7.5 Certification rules

You must enter students for qualification certification separately from unit assessment(s). If a certification entry is **not** made, no overall grade can be awarded. These are the qualifications that students should be entered for:

- OCR Level 3 Cambridge Advanced National (AAQ) in Engineering (Certificate) - certification code H027.
- OCR Level 3 Cambridge Advanced National (AAQ) in Engineering (Extended Certificate) - certification code H127.

## 7.6 Unit and qualification resits

Students can resit each unit and the best result will be used to calculate the certification result.

Resit opportunities must be fair to all students and **not** give some students an unfair advantage over other students. For example, the student must not have direct guidance and support from the teacher in producing further evidence for NEA units. When resitting a NEA unit, students must submit new, amended or enhanced work, as detailed in the JCQ **Instructions for Conducting Coursework**.

When you arrange resit opportunities, you must make sure that you do not adversely affect other assessments being taken.

Arranging a resit opportunity is at the centre's discretion. Summative assessment series must not be used as a diagnostic tool and resits should only be planned if the student has taken full advantage of the first assessment opportunity and any formative assessment process.

## 7.7 Post-results services

A number of post-results services are available:

- Reviews of results - if you think there might be something wrong with a student's results, you may submit a review of marking or moderation.
- Missing and incomplete results - if an individual subject result for a student is missing, or the student has been omitted entirely from the results supplied you should use this service.
- Access to scripts - you can ask for access to marked scripts.
- Late certification - following the release of unit results, if you have not previously made a certification entry, you can make a late request, which is known as a **late certification**. This is a free service.

Please refer to the JCQ **Post-Results Services booklet** and the **OCR Administration page** for more guidance about action on the release of results.

For NEA units the enquiries on results process cannot be carried out for one individual student; the outcome of a review of moderation must apply to a centre's entire cohort.

# Appendix A: Guidance for the production of electronic evidence

## Structure for evidence

The NEA units in these qualifications are units F132 - F137. For each student, all the tasks together will form a portfolio of evidence, stored electronically. Evidence for each unit must be stored separately.

A NEA portfolio is a collection of folders and files containing the student's evidence. Folders should be organised in a structured way so that the evidence can be accessed easily by a teacher or OCR assessor. This structure is commonly known as a folder tree. It would be helpful if the location of particular evidence is made clear by naming each file and folder appropriately and by use of an index called 'Home Page'.

There should be a top-level folder detailing the student's centre number, OCR candidate number, surname and forename, together with the unit code (F132 - F137), so that the portfolio is clearly identified as the work of one student.

Each student's portfolio should be stored in a secure area on the centre's network. Before submitting the portfolio to OCR, the centre should add a folder to the folder tree containing the internal assessment and summary forms.

## Data formats for evidence

It is necessary to save students' work using an appropriate file format to minimise software and hardware capability issues.

Students must use formats appropriate:

- to their evidence
- for viewing for assessment and moderation.

Formats must be open file formats or proprietary formats for which a downloadable reader or player is available. If a downloadable reader or player is not, the file format is **not** acceptable.

Evidence submitted is likely to be in the form of word-processed documents, presentation documents, digital photos and digital video.

All files submitted electronically must be in the formats listed on the following page. Where new formats become available that might be acceptable, we will give more guidance. It is the centre's responsibility to make sure that the electronic portfolios submitted for moderation are accessible to the OCR assessor and fully represent the evidence available for each student.

Standard file formats acceptable as evidence for the Cambridge Advanced Nationals (AAQs) are listed here.

File type	File format	Max file size*
Audio	.3g2 .3ga .aac .aiff .amr .m4a .m4b .m4p .mp3 .wav	25GB
Compression	.zip .zipx .rar .tar .tar .gz .tgz .7z .zipx .zz	25GB
Data	.xls .xlsx .mdb .accdb .xlsb	25GB
Document	.odt .pdf .rtf .txt .doc .docx .dotx .	25GB
Image	.jpg .png .jpeg .tif .jfif .gif .psd .dox .pcx .bmp .wmf	15MB
Presentation	.ppt .pptx .pdf .gslides .pptm .odp .ink .potx .pub	25GB
Video	.3g2 .3gp .avi .flv .m4v .mkv .mov .mp4 .mp4v .wmp .wmv	25GB
Web	.wlmf .mts .mov-1 .mp4-1 .xspf .mod .mpg	25GB

If you are using **.pages** as a file type, please convert this to a **.pdf** prior to submission.

\*max file size is only applicable if using our Submit for Assessment service.

**Submit for Assessment** is our secure web-based submission service. You can access Submit for Assessment on any laptop or desktop computer running Windows or macOS and a compatible browser. It supports the upload of files in the formats listed in the table above as long as they do not exceed the maximum file size. Other file formats and folder structures can be uploaded within a compressed file format.

When you view some types of files in our Submit for Assessment service, they will be streamed in your browser. It would help your OCR assessor or examiner if you could upload files in the format shown in the table below:

File type	File format	Chrome	Firefox
Audio	.mp3	Yes	Yes
Audio	.m4a	Yes	Yes
Audio	.aac	No	Yes
Document	.txt	Yes	Yes
Image	.png	Yes	Yes
Image	.jpg	Yes	Yes
Image	.jpeg	Yes	Yes
Image	.gif	Yes	Yes
Presentation	.pdf	Yes	Yes
Video	.mp4	Yes	Yes
Video	.mov	No	Yes
Video	.3gp	Yes	No
Video	.m4v	Yes	Yes
Web	.html	Yes	Yes
Web	.htm	Yes	Yes

## Appendix B: Command Words

### External assessment

The table below shows the command words that will be used in exam questions. This shows what we mean by the command word and how students should approach the question and understand its demand. Remember that the rest of the wording in the question is also important.

Command Word	Meaning
<b>Analyse</b>	<ul style="list-style-type: none"><li>• Separate or break down information into parts and identify their characteristics or elements</li><li>• Explain the different elements of a topic or argument and make reasoned comments</li><li>• Explain the impacts of actions using a logical chain of reasoning</li></ul>
<b>Annotate</b>	<ul style="list-style-type: none"><li>• Add information, for example, to a table, diagram or graph</li></ul>
<b>Choose</b>	<ul style="list-style-type: none"><li>• Select an answer from options given</li></ul>
<b>Compare</b>	<ul style="list-style-type: none"><li>• Give an account of the similarities and differences between two or more items or situations</li></ul>
<b>Complete</b>	<ul style="list-style-type: none"><li>• Add information, for example, to a table, diagram or graph to finish it</li></ul>
<b>Describe</b>	<ul style="list-style-type: none"><li>• Give an account that includes the relevant characteristics, qualities or events</li></ul>
<b>Discuss</b> (how/whether/etc)	<ul style="list-style-type: none"><li>• Present, analyse and evaluate relevant points (for example, for/against an argument) to make a reasoned judgement</li></ul>
<b>Draw</b>	<ul style="list-style-type: none"><li>• Produce a picture or diagram</li></ul>
<b>Explain</b>	<ul style="list-style-type: none"><li>• Give reasons for and/or causes of something</li><li>• Make something clear by describing and/or giving information</li></ul>
<b>Give examples</b>	<ul style="list-style-type: none"><li>• Give relevant examples in the context of the question</li></ul>
<b>Identify</b>	<ul style="list-style-type: none"><li>• Name or provide factors or features from stimulus</li></ul>
<b>Label</b>	<ul style="list-style-type: none"><li>• Add information, for example, to a table, diagram or graph until it is final</li></ul>
<b>Outline</b>	<ul style="list-style-type: none"><li>• Give a short account or summary</li></ul>
<b>State</b>	<ul style="list-style-type: none"><li>• Give factors or features</li><li>• Give short, factual answers</li></ul>

## **Additional EA commands for Engineering**

Where working **has** to be shown to support an answer the question will make this clear by including the statement 'You must show your working'.

For other questions, where an answer could be obtained from the efficient use of a calculator, either graphically or using a numerical method, working does not **need** to be shown for full marks. However, it is best practice to show your working as marks might be given for using a correct method, even if your answer is wrong.

Some command words implicitly require that workings are always shown given their definitions for example 'Show that' and 'Determine'.

<b>Word</b>	<b>Definition</b>
<b>Calculate, Find, Solve</b>	Work out a numerical value; a solution; or the value of a variable in the context of a given equation.
<b>Show that</b>	Show that a given result is true. Because the result is given, the explanation has to be sufficiently detailed to cover every step of working.
<b>Simplify</b>	Reduce an expression, fraction or problem to a simpler form.
<b>Rearrange</b>	Move items in equations or formulae around to make a different variable the subject or find an answer.
<b>Write as/in the form</b>	Write a response in the form requested in the question.
<b>Prove</b>	Provide a mathematical argument which demonstrates the validity of a given statement.  A formal proof requires a high level of mathematical detail, with students clearly defining variables, correct algebraic manipulation and a concise conclusion.
<b>Determine</b>	Find out, decide, e.g. what is relevant.  To find a solution by following a set of procedures or to obtain a conclusion, or a numerical value by carrying out a series of calculations.  This command word indicates that justification should be given for any results found, including workings.
<b>Hence</b>	When a question uses the word 'hence', it is an indication that the next step should be based on what has gone before. The intention is that students should start from the indicated statement.
<b>Sketch</b>	Draw a diagram, not necessarily to scale, showing the main features of a curve.
<b>Plot</b>	Mark points accurately on a graph. These may need to be joined with a curve or a straight line, or a line of best fit drawn through them.

## Non examined assessment (NEA)

The table shows the command words that will be used in the NEA assignments and/or assessment criteria.

Command Word	Meaning
<b>Adapt</b>	<ul style="list-style-type: none"><li>• Change to make suitable for a new use or purpose</li></ul>
<b>Analyse</b>	<ul style="list-style-type: none"><li>• Separate or break down information into parts and identify their characteristics or elements</li><li>• Explain the different elements of a topic or argument and make reasoned comments</li><li>• Explain the impacts of actions using a logical chain of reasoning</li></ul>
<b>Assess</b>	<ul style="list-style-type: none"><li>• Offer a reasoned judgement of the standard or quality of situations or skills. The reasoned judgement is informed by relevant facts</li></ul>
<b>Calculate</b>	<ul style="list-style-type: none"><li>• Work out the numerical value. Show your working unless otherwise stated</li></ul>
<b>Classify</b>	<ul style="list-style-type: none"><li>• Arrange in categories according to shared qualities or characteristics</li></ul>
<b>Compare</b>	<ul style="list-style-type: none"><li>• Give an account of the similarities and differences between two or more items, situations or actions</li></ul>
<b>Conclude</b>	<ul style="list-style-type: none"><li>• Judge or decide something</li></ul>
<b>Describe</b>	<ul style="list-style-type: none"><li>• Give an account that includes the relevant characteristics, qualities or events</li></ul>
<b>Discuss</b> (how/whether/etc)	<ul style="list-style-type: none"><li>• Present, analyse and evaluate relevant points (for example, for/against an argument) to make a reasoned judgement</li></ul>
<b>Evaluate</b>	<ul style="list-style-type: none"><li>• Make a reasoned qualitative judgement considering different factors and using available knowledge/experience</li></ul>
<b>Examine</b>	<ul style="list-style-type: none"><li>• To look at, inspect, or scrutinise carefully, or in detail</li></ul>
<b>Explain</b>	<ul style="list-style-type: none"><li>• Give reasons for and/or causes of something</li><li>• Make something clear by describing and/or giving information</li></ul>
<b>Interpret</b>	<ul style="list-style-type: none"><li>• Translate information into recognisable form</li><li>• Convey one's understanding to others, e.g. in a performance</li></ul>
<b>Investigate</b>	<ul style="list-style-type: none"><li>• Inquire into (a situation or problem)</li></ul>
<b>Justify</b>	<ul style="list-style-type: none"><li>• Give valid reasons for offering an opinion or reaching a conclusion</li></ul>
<b>Research</b>	<ul style="list-style-type: none"><li>• Do detailed study in order to discover (new) information or reach a (new) understanding</li></ul>
<b>Summarise</b>	<ul style="list-style-type: none"><li>• Express the most important facts or ideas about something in a short and clear form</li></ul>

We might also use other command words but these will be:

- commonly used words whose meaning will be made clear from the context in which they are used (e.g. create, improve, plan)
- subject specific words drawn from the unit content.



# Examine *with us*

- Build confidence supporting your students with assessment
- Enhance subject knowledge
- Great for professional development



Join our team: [ocr.org.uk/assessor](https://ocr.org.uk/assessor)

**OCR**  
Oxford Cambridge and RSA



These are draft documents and some aspects may not be fully accessible. If you have any problems with the accessibility of this format, please [contact us](#).

**Contact the team at:**

 **01223 553998**

 **support@ocr.org.uk**

 **ocr.org.uk**

 **facebook.com/ocrexams**

 **twitter.com/ocrexams**

 **instagram.com/ocrexaminations**

 **linkedin.com/company/ocr**

 **youtube.com/ocrexams**

To stay up to date with all the relevant news about our qualifications, register for email updates at [ocr.org.uk/updates](https://ocr.org.uk/updates)

Visit our Online Support Centre at [support.ocr.org.uk](https://support.ocr.org.uk)



OCR is part of Cambridge University Press & Assessment, a department of the University of Cambridge.

For staff training purposes and as part of our quality assurance programme your call may be recorded or monitored. ©OCR 2023 Oxford Cambridge and RSA Examinations is a Company Limited by Guarantee. Registered in England. Registered office The Triangle Building, Shaftesbury Road, Cambridge, CB2 8EA. Registered company number 3484466. OCR is an exempt charity.

OCR operates academic and vocational qualifications regulated by Ofqual, Qualifications Wales and CCEA as listed in their qualifications registers including A Levels, GCSEs, Cambridge Technicals and Cambridge Nationals.

Cambridge University Press & Assessment is committed to making our documents accessible in accordance with the WCAG 2.1 Standard. We're always looking to improve the accessibility of our documents. If you find any problems or you think we're not meeting accessibility requirements, please [contact us](#).

OCR acknowledges the use of the icons by appleuzr, sourced from gettyimages.co.uk.